

**CROSSPRO**

**OFF-ROAD #2022**

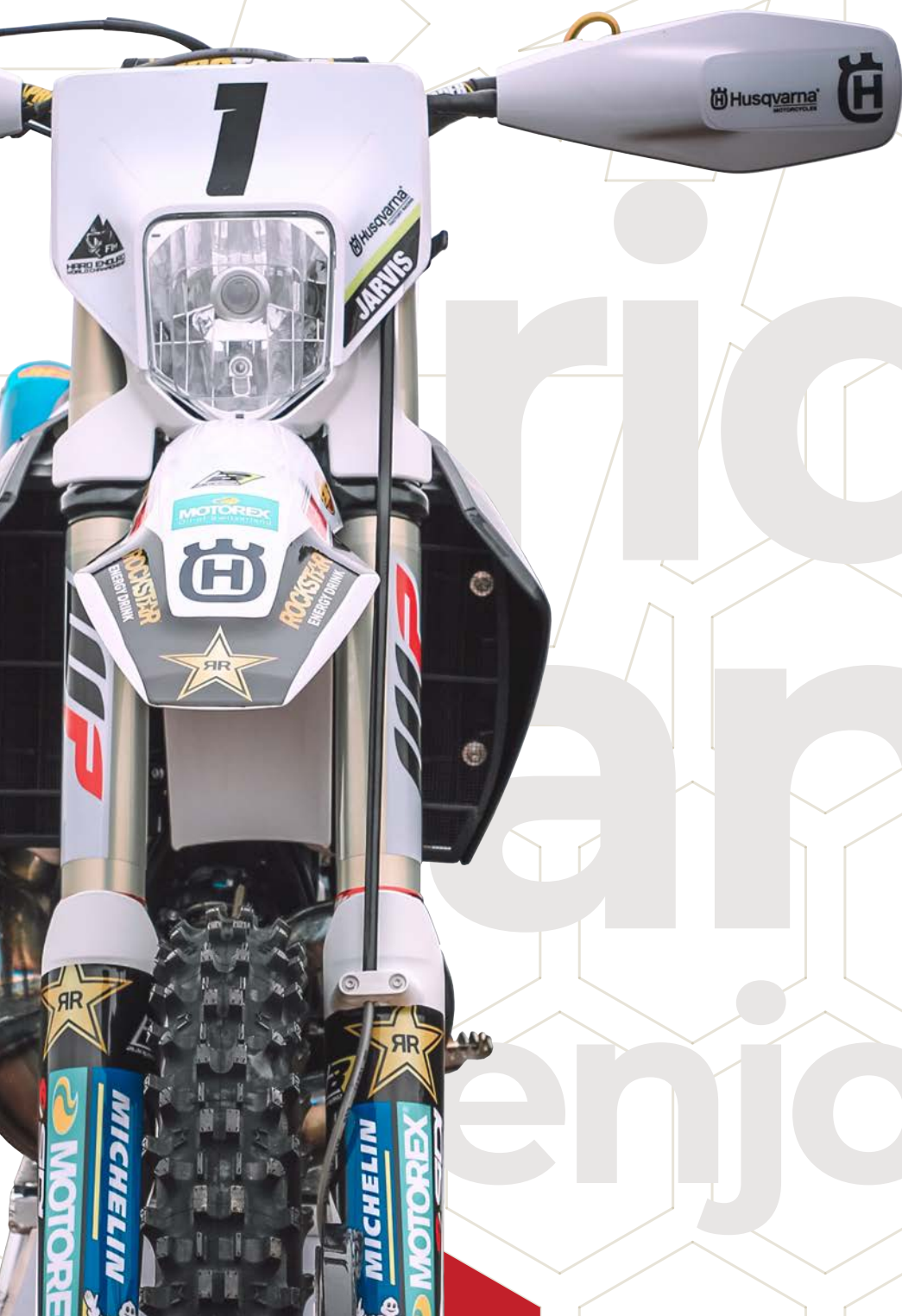

ride  
and  
enjoy it



# THE CHOICE OF A ETERNAL CHAMPION



THANK YOU PAULO, FOR BEING  
PART OF OUR FAMILY

*Em 2005 nasce a CrossPro, uma empresa que se dedica a produção de protecções e acessórios para veículos de 2 e 4 rodas. A paixão e conhecimento dos seus fundadores sobre a modalidade e mecânica, permitiram um rápido e sustentável crescimento da CrossPro.*

*Rapidamente, a CrossPro alcançou na Europa uma respeitável reputação pela produção e desenvolvimento dos seus produtos, as soluções oferecidas permitiram alcançar novos mercados e actualmente assegurar a presença a nível mundial em mercados muito distintos, mas ao mesmo tempo tão exigentes como o Europeu.*

*Os nossos produtos são fabricados na nossa unidade fabril em Portugal, sendo submetidos a um rigoroso controlo de qualidade para assegurar a qualidade dos produtos oferecidos. A aposta na melhoria contínua dos nossos produtos e processos, conferem aos produtos que oferecemos uma diferenciação no mercado.*

*Todos os produtos da CrossPro são submetidos a testes em condições extremas, o que nos permite obter o produto final adequado ao consumidor final, sendo ele profissional ou amador, garantindo um máxima performance.*

*Apostamos no aumento da nossa gama, estando atentos as novas tendências dos mercados, procurando antecipar as necessidades dos nossos actuais e potenciais clientes, desenvolvendo novas soluções para estes.*

*A nossa gama ao longo da nossa existência tornou-se cada vez mais ajustada ao consumidor e as suas exigências, o feedback do cliente ajuda-nos a melhorar e ajustar o produto.*

*A mudança de instalações em 2017, agora com 5000m<sup>2</sup>, aliada ao investimento em nova maquinaria (corte a laser, célula de solda robotizada, maquina de lixar por planos, unidade de pintura Eletróstática, entre outras) bem como o Know-How, permitiu ainda a CrossPro entrar em novas áreas de negócios, aumentando as nossas valências como metalomecânica e produtores dos mais variados produtos.*

*CrossPro é sinónimo de qualidade para o cliente.*

In 2005 CrossPro was born, a company dedicated to the production of protections and accessories for 2 and 4 wheel vehicles. Their founders' passion and knowledge of the sport and mechanics allowed CrossPro to grow rapidly and sustainably.

CrossPro quickly achieved a respectable reputation in Europe for the production and development of its products, the solutions offered have made it possible to reach new markets and today ensure a worldwide presence in very different markets, but at the same time as demanding as the European market.

Our products are manufactured in our factory in Portugal and are subject to strict quality control to ensure the quality of the products offered. The bet on the continuous improvement of our products and processes, give the products we offer a differentiation in the market.

All CrossPro products are tested under extreme conditions, allowing us to obtain the final product suitable for the end consumer, whether professional or amateur, ensuring maximum performance.

We focus on increasing our range, being aware of new market trends, seeking to anticipate the needs of our current and potential customers, developing new solutions for them.

Our range over our lifetime has become increasingly consumer-adjusted and their requirements, customer feedback helps us improve and adjust the product.

The change of installations in 2017, now with 5000 sqm, combined with investment in new machinery (laser cutting, robotic welding cell, flat sanding machine, electrostatic painting unit, among others) as well as Know-How, also allowed CrossPro enters new business areas, increasing our skills as a metalworker and producers of various products.

CrossPro stands for quality.



# RIDE AND ENJOY IT



**CENTRO** 2020



UNÃO EUROPEIA  
Fundo Europeu  
de Desenvolvimento Regional



Management  
System  
ISO 9001:2015



www.tuv.com  
ID 9105077726

<b>08</b>	<b>44</b>	<b>50</b>	<b>56</b>	<b>116</b>	<b>124</b>
OFF-ROAD	ACCESSORIES	BIKE STANDS	SPORTS QUAD	UTILITY ATVs	SIDE BY SIDE

# CONTENT

# ride and enjoy it

---

*//A CrossPro atenta às tendências, acompanhou o crescimento deste segmento (dual-sports), desenvolvendo Protecções de Carenagem completas bem como Protecções de Motor, que permitem uma protecção total das zonas críticas da moto.*

*As nossas protecções diferenciam-se das da concorrência na matéria prima, o alumínio. As protecções de alumínio oferecem vantagens como:*

*•Preocupações ambientais são um dos temas mais sensíveis da actualidade a diferença substancial de peso das nossas protecções, leva a uma redução de consumos e desgaste da moto.*

*•Maior leveza, aumenta performance e segurança da sua condução*

*•Não oxida, a sua protecção manterá a cor e aspecto novo por mais tempo*

*•Personalização, um leque de cores disponíveis que lhe permitirá ter a protecção a seu gosto*

*Além das protecções referidas, a CrossPro está a desenvolver para estes modelos uma linha de acessórios de protecção de zonas mais sensíveis, com um design discreto mas com a máxima protecção.*

*Os acessórios desenvolvidos, combinam alumínio e aço inox para garantir a protecção destas zonas.*

*//CrossPro, keeping up with the trends, followed the growth of this segment by developing complete Crash Bars as well as Engine Guards that allow full protection of critical areas of the motorcycle.*

Our protections differ from the competition in the raw material, the aluminum. Aluminum protections offer advantages such as:

•Environmental concerns are one of the most sensitive issues today, the substantial difference in weight of our protections, leading to a reduction in fuel consumption and motorcycle ridding.

•Increased lightness, increased performance and driving safety.

•Does not oxidize, the protection will keep the color and look new longer

•Personalization, a range of available colors that will allow you to have the protection to your liking.

In addition to the above protections, CrossPro is developing a range of accessories, for the protections of the more sensitive zone of your bike, with a discreet design but maximum protection.

The developed accessories combine aluminum and stainless steel to ensure the protection of these areas.



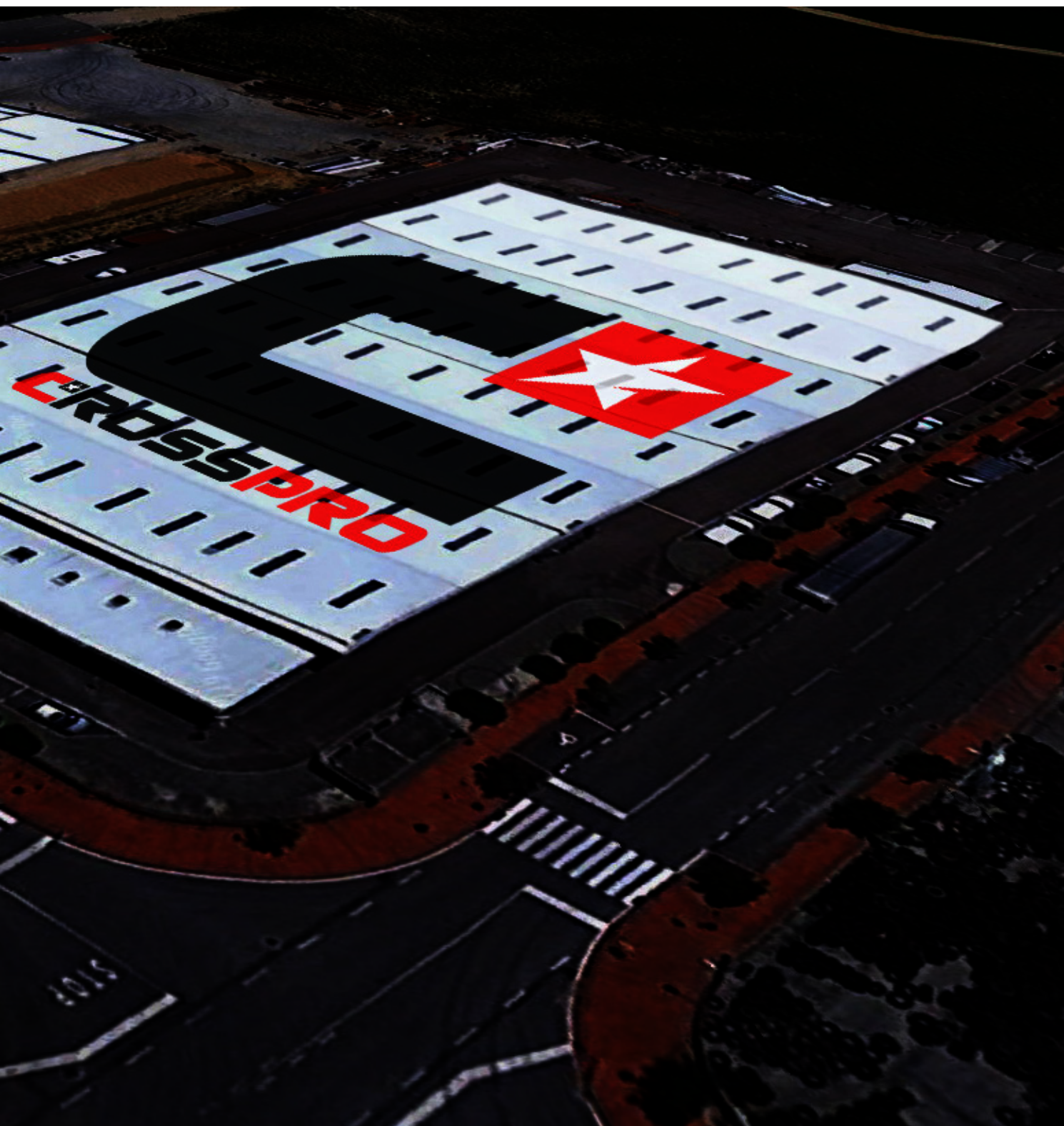

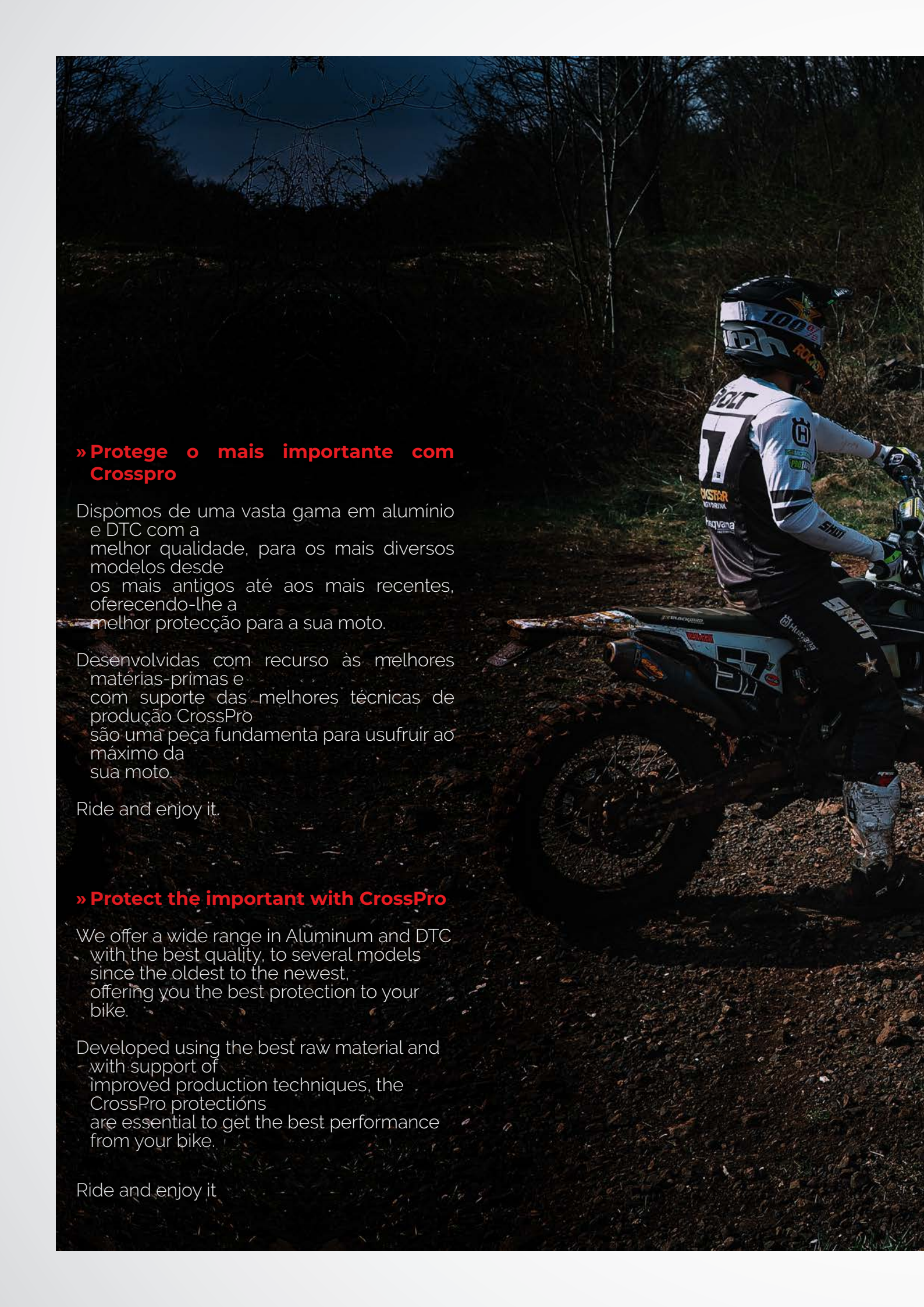

**» Protege o mais importante com Crosspro**

Dispomos de uma vasta gama em alumínio e DTC com a melhor qualidade, para os mais diversos modelos desde os mais antigos até aos mais recentes, oferecendo-lhe a melhor protecção para a sua moto.

Desenvolvidas com recurso às melhores matérias-primas e com suporte das melhores técnicas de produção CrossPro são uma peça fundamenta para usufruir ao máximo da sua moto.

Ride and enjoy it.

**» Protect the important with CrossPro**

We offer a wide range in Aluminum and DTC with the best quality, to several models since the oldest to the newest, offering you the best protection to your bike.

Developed using the best raw material and with support of improved production techniques, the CrossPro protections are essential to get the best performance from your bike.

Ride and enjoy it





**off-road**  
**racing**  
**protection**

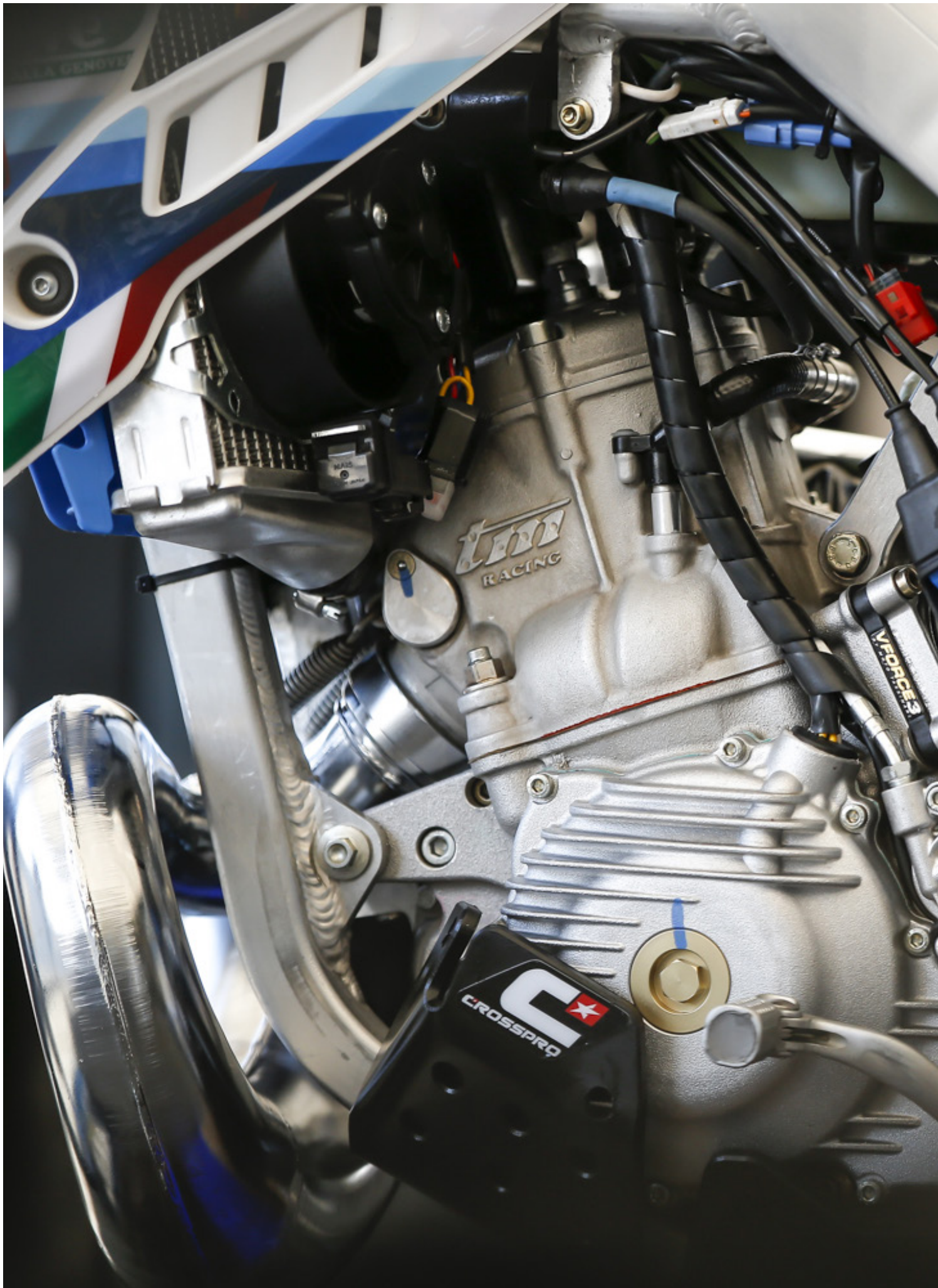







# HARD LINK DTC Engine Guard

•2CP225\_



- » Replace the (\*\*\*\*) for the code of the desired color Example: Red Color 2CP2250183**0500**
- » Substituir os (\*\*\*\*) pelo código de cor pretendida:Exemplo: para a cor vermelha 2CP2250183**0500**

● »0300	● »0400	● »0500	● »0600	● »0700	● »0900
Black Preto	Blue Azul	Red Vermelho	White Branco	Yellow Amarelo	Orange Laranja





#### **Proteções de motor DTC com proteção de link reforçado**

A máxima exigência dos nossos clientes, as novas tendências e a filosofia de melhoria contínua, naturalmente levaram ao upgrade das protecções de DTC desenvolvidas.

A nova protecção, além do reforço da zona do link, tem um reforço nas zonas do quadro, aumentando a protecção da sua moto.

- Extra protecção na zona de link, agora com 12mm que reforçará a protecção desta zona sensível da sua moto
- De fácil aplicação, pode remover ou colocar ajustando a protecção à exigência de cada corrida
- Protecção ajustada e adequada a corridas com mais obstáculos
- Removível e de fácil substituição

#### **DTC HARD engine guard with link reinforcement protection**

The maximum demand of our customers, the new trends and the philosophy of continuous improvement, naturally led to the upgrade of the developed DTC protections.

The new protection, in addition to strengthening the link area, has a reinforcement in the areas of the frame, increasing the protection of your bike.

- Extra protection for the link, now with 12mm that will reinforce the protection in this sensible part of your bike
- Easy to apply, you can remove or putt adjusting the skidplate to the "hardness" of each race
- Protection adjusted to races with more obstacles
- Removable and easily replaceable









# LINK DTC

• 2CP193\_





# Engine Guard

## Proteções de motor DTC com proteção de link

//Detetando a necessidade crescente de aumentar a proteção das motos, a CrossPro introduz na sua gama uma Proteção de Motor em DTC, que protege agora também o Link de Suspensão.

// Uma peça única e completa para proteção da sua moto, carter, quadro e Link de suspensão.

// Proteção extra para condições extremas

// Testado em competição

// Produzido em DTC da melhor qualidade com 6mm, sem solda, estas proteções de motor são 40% mais leves que o alumínio, não quebram e não causam vibrações, e muito mais resistente ao impacto.

// Disponível em diferentes cores

» Replace the (\*\*\*\*) for the code of the desired color Example: Red Color 2CP1930183**0500**

» Substituir os (\*\*\*\*) pelo código de cor pretendida.Exemplo: para a cor vermelha 2CP1930183**0500**

● »0300  
Black  
Preto

● »0400  
Blue  
Azul

● »0500  
Red  
Vermelho

● »0600  
White  
Branco

● »0700  
Yellow  
Amarelo

● »0900  
Orange  
Laranja



## DTC enduro engine guard with link protection

//Noting the increasing necessity to protect more the bikes, CrossPro introduce in the range the DTC Engine Protection, that now also protect the Suspension Link.

//One complete piece for protect your bike for frame, carter and suspension link protection

//Extra protection for extreme conditions

//Made by 6mm best quality DTC, with no welding, these engine guards are 40% lighter than aluminum, dont break and dont cause vibrations, and is much more resistant to impact.

//Available in different colors

OTO.COM

ENDUROGP.COM



2021 BORILLI ENDURO

# GP OF PORTUGAL

MARCO DE CANAVES



AKRAPOVIČ  
BORILLI  
JUST  
NERVE  
bis  
CHA  
AKRAPO  
UROGP.COM  
ACE  
AIROH  
PERFORMANCE  
ENDURO  
AMVIC  
BRICANTS  
POLLSPON  
30  
CHAMPION





### Protecções de motor DTC enduro

//Testado em competição, estas protecções de motor oferecem a melhor protecção para o motor e para o quadro de sua moto.

//Produzido em DTC da melhor qualidade com 6mm, sem solda, estas protecções de motor são 40% mais leves que o alumínio, não quebram e não causam vibrações, e são muito mais resistente ao impacto.

//Disponíveis em diferentes cores

### DTC enduro engine guard

//Tested in competition, these engine guards offer you the best protection for the engine and for the frame of your bike.

//Made by 6mm best quality DTC, with no welding, these engine guards are 40% lighter than aluminum, don't break and don't cause vibrations, and is much more resistant to impact.

//Available in different colors





# ENDURO DTC Engine Guard

•2CP085\_



» Replace the (\*\*\*\*) for the code of the desired color Example: Red Color 2CP0850183**0500**

» Substituir os (\*\*\*\*) pelo código de cor pretendida:Exemplo: para a cor vermelha 2CP0850183**0500**

● »0300  
Black  
Preto

● »0400  
Blue  
Azul

● »0500  
Red  
Vermelho

● »0600  
White  
Branco

● »0700  
Yellow  
Amarelo

● »0900  
Orange  
Laranja







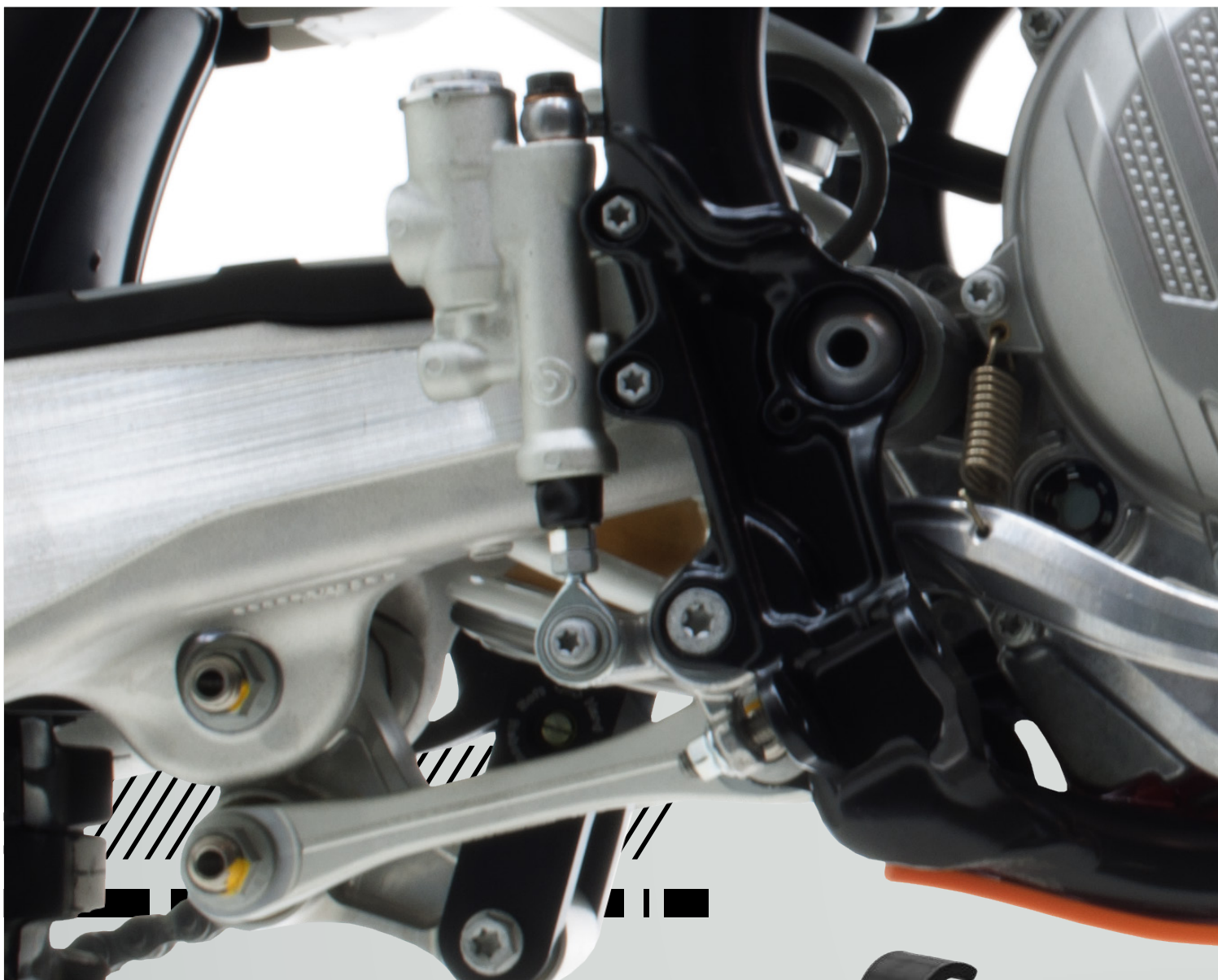



# MXDTC Engine Guard .2CP079\_

- » Replace the (\*\*\*\*) for the code of the desired color Example: Red Color 2CP0790183**0500**
- » Substituir os (\*\*\*\*) pelo código de cor pretendida.Exemplo: para a cor vermelha 2CP0790183**0500**

»0300  
Black  
Preto

»0400  
Blue  
Azul

»0500  
Red  
Vermelho

»0600  
White  
Branco

»0700  
Yellow  
Amarelo

»0900  
Orange  
Laranja

## Protecções de motor DTC motocross

//Testado em competição, estas protecções de motor oferecem a melhor protecção para o motor e para o quadro de sua moto.  
//Produzido em DTC da melhor qualidade com 6mm, sem solda, estas protecções de motor são 40% mais leves que o alumínio, não quebram e não causam vibrações, e são muito mais resistente ao impacto.  
//Disponíveis em diferentes cores você pode escolher agora as melhores protecções de sempre para a sua moto.

## DTC motocross Engine Guard

//Tested in competition, these engine guards offer you the best protection for the engine and for the frame of your bike.  
//Made by 6mm best quality DTC, with no welding, these engine guards are 40% lighter than aluminum, don't break and don't cause vibrations, and is much more resistant to impact.  
//Available in different colors







# ENDURO

## ALUMINUM

### Engine Guard

•2CP059\_



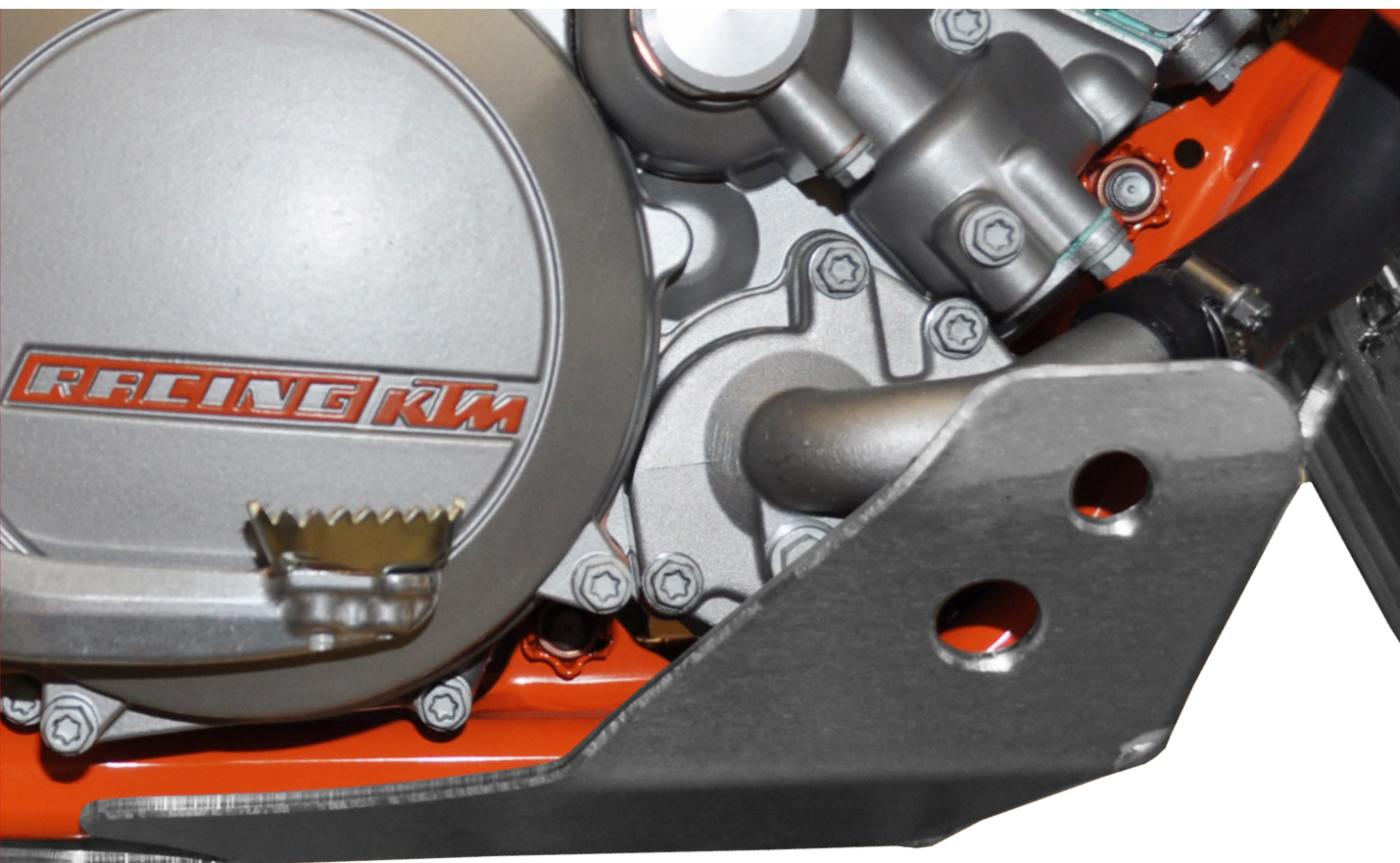

### Protecções de motor enduro em alumínio

//As Protecções de Motor de Enduro da Crosspro oferecem a máxima protecção, sendo extremamente leves  
 //Cobrem totalmente o motor da sua moto, garantindo a máxima protecção contra impactos e projecções de pedras  
 //Produzidas em alumínio da mais alta qualidade, com espessura de 4mm

### Enduro aluminum engine guard

//These aluminum skid plates offer the maximum of protection for a minimum weight  
 //They wrap around the bottom and both sides of the engine providing your bike with perfect protection against rocks  
 //Made by best quality aluminum, with a thickness of 4mm

- » Replace the (\*\*\*\*) for the code of the desired color Example: Red Color 2CP059005**10007**
- » Substituir os (\*\*\*\*) pelo código de cor pretendida:Exemplo: para a cor vermelha 2CP059005**10007**

 »0001 Ice Matte	 »0002 Polish Polido	 »0003 Neutral Natural	 »0004 Black Preto	 »0011 Blue Azul	 »0007 Red Vermelho	 »0006 White Branco	 »0008 Yellow Amarelo	 »0010 Orange Laranja	 »0009 Green Verde
---	--	--	--	--	---	---	---	---	--







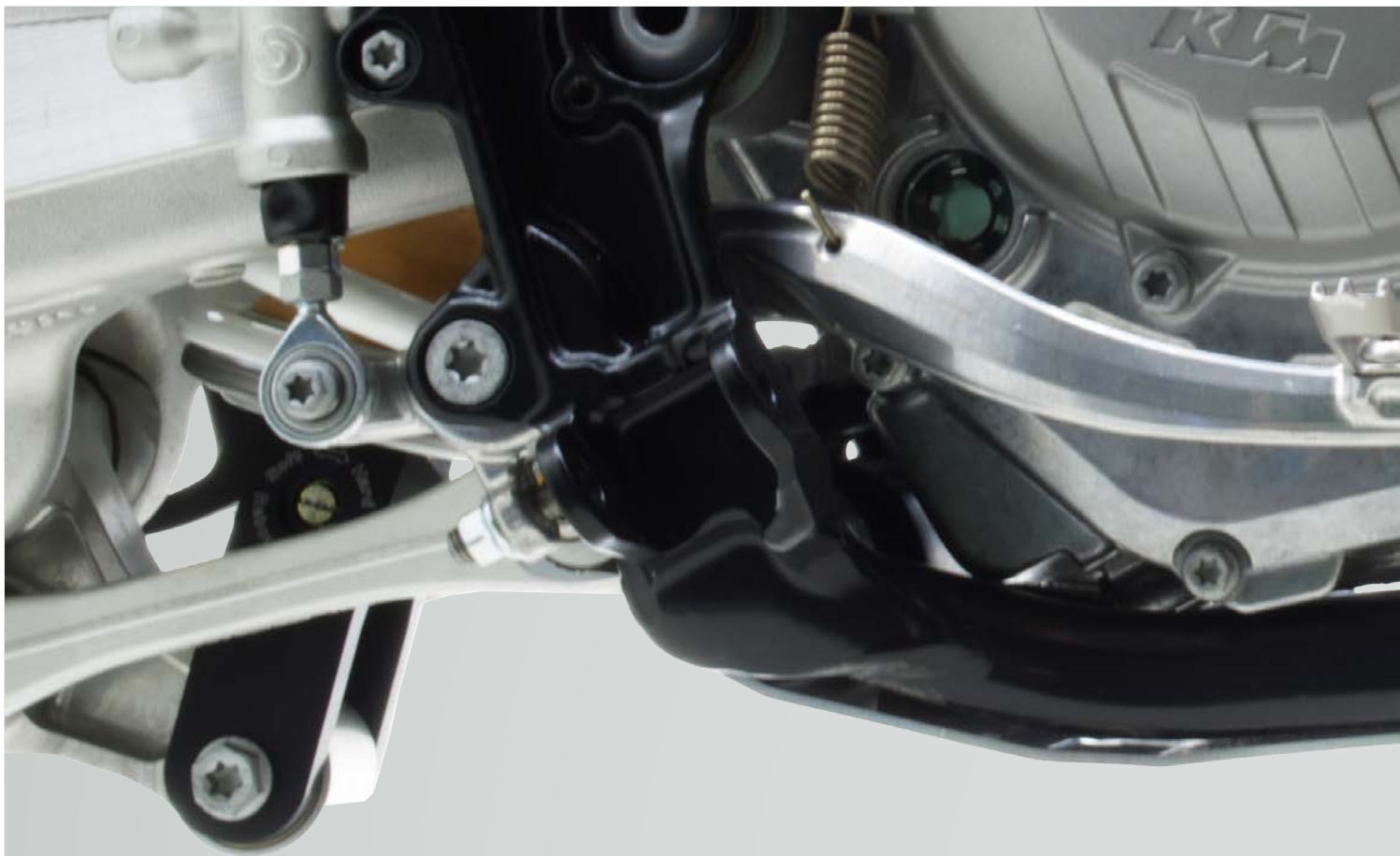

# MX

## ALUMINUM Engine Guard

•2CP06L



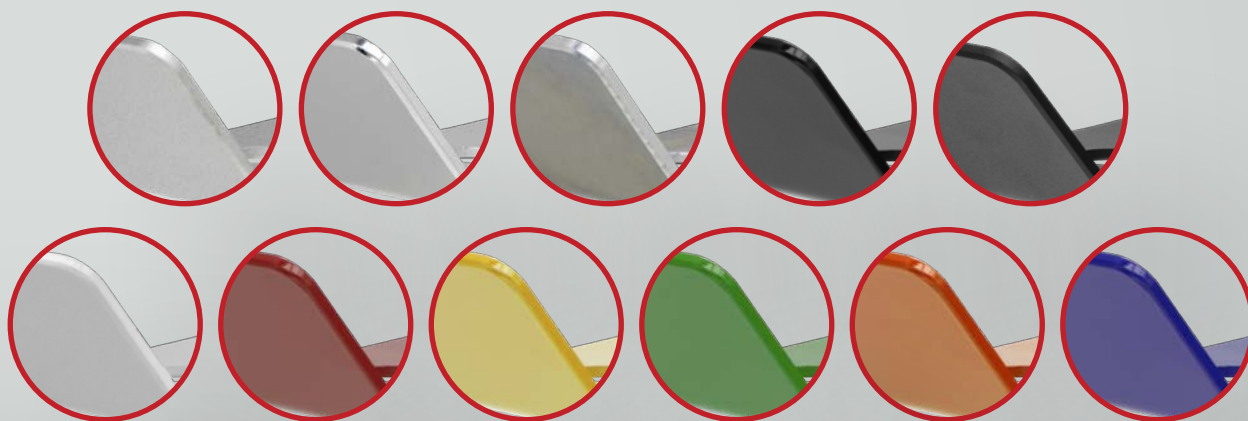

### Protecções de motor motocross em alumínio

//As protecções de motor CrossPro de Motocross e Supermoto, asseguram a máxima protecção ao seu motor, permitindo deslizar sobre todos os obstáculos

//As protecções protegem também a parte inferior do quadro da moto.

//A máxima protecção, a simplicidade de montagem e a qualidade final do produto, são as principais razões pelas quais deverá equipar a sua moto com as protecções de motor CrossPro

//Produzidas em alumínio da mais alta qualidade, com espessura de 4mm

### Motocross aluminum engine guard

//CrossPro motocross and supermoto plates give your engine and lower frame, the protection they need helping you glide over obstacles

//Our coverage, simplicity of mounting, and product finally quality are the reasons why you should equip your bike with CrossPro glide

//Made by best quality aluminum, with a thickness of 4mm

» Replace the (\*\*\*\*) for the code of the desired color Example: Red Color 2CP06100510007

» Substituir os (\*\*\*\*) pelo código de cor pretendida.Exemplo: para a cor vermelha 2CP06100510007

 »0001	 »0002	 »0003	 »0004	 »0011	 »0007	 »0006	 »0008	 »0010	 »0009
Ice Matte Ice Polish	Polish Polido	Neutral Natural	Black Preto	Blue Azul	Red Vermelho	White Branco	Yellow Amarelo	Orange Laranja	Green Verde







# RADIATOR GUARD ALUMINUM

•2CP060\_

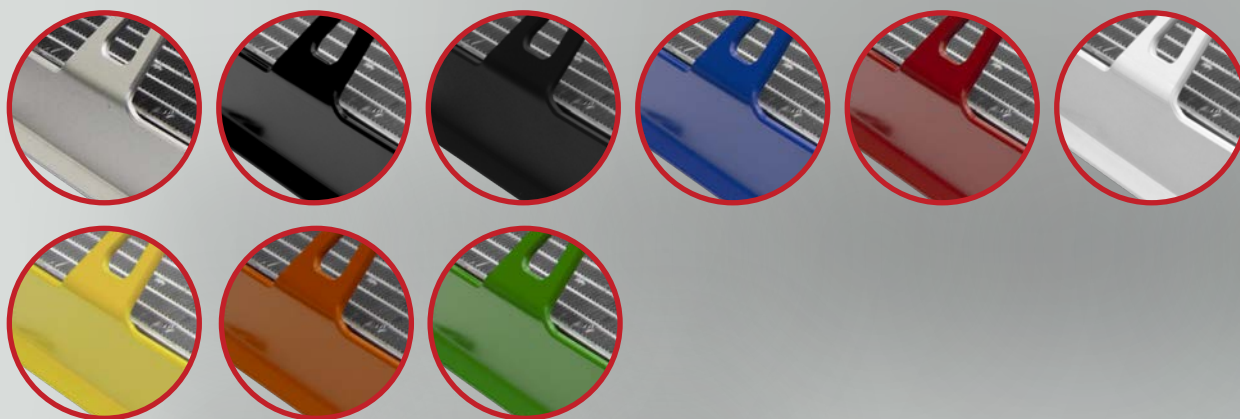

## Protecções de radiador em alumínio

//As protecções de radiador Light CrossPro foram desenvolvidas para proteger o sistema de refrigeração (a parte mais frágil e importante da sua moto). Não obstrui o fluxo de ar necessário para o devido arrefecimento

//Desenhado como uma espécie de "Concha", a protecção de radiador assegura um perímetro de segurança, sem que os seus pontos de fixação estejam em contacto directo com o radiador. A fixação é efectuada ao quadro da moto.

//Com este perímetro de segurança, os impactos nunca serão transmitidos directamente ao radiador

//Produzidas em alumínio da mais alta qualidade, com espessura de 3mm.

## Radiator aluminum guard

//The CrossPro radiator were specially designed to protect your Cooling System, your bike's most fragile and important component - without obstructing airflow to the radiator









//Designed as a "radiator roll cage", the CrossPro radiator protection secures a perimeter around the radiator, without its fixation points are in direct contact with the radiator

//With this security perimeter, hard impacts won't affect your radiator

//Made by best quality aluminum, with a thickness of 3mm

» Replace the (\*\*\*\*) for the code of the desired color Example: Red Color 2CP06000510007

» Substituir os (\*\*\*\*) pelo código de cor pretendida.Exemplo: para a cor vermelha 2CP06000510007

 »0001	 »0004	 »0011	 »0007	 »0006	 »0008	 »0010	 »0009
Ice Matte	Black Preto	Blue Azul	Red Vermelho	White Branco	Yellow Amarelo	Orange Laranja	Green Verde

 Husqvarna®  
FACTORY RACING

**BILLY**  
**HARD ENDURO**  
**WORLD**  
**CHAMPION**  
**2021**









# REAR BRAKE DISC GUARDS



• 2CP092\_

## • DTC COLOR AVAILABLE:

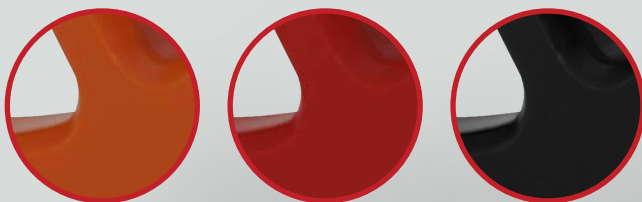

• Aluminum 5mm • 2CP074\_

### Protecções de disco traseiro

//As Protecções de Disco Traseiras, foram desenvolvidas de forma a assegurar protecção extra para a sua mota, prevenindo danos.

//As protecções foram desenhadas para assegurar:

- Protecção Extra
- Limpeza fácil
- Design atraente

//Material:

- Alumínio de 5mm, disponível em IcePolish ou Preto
- DTC de 15mm, disponível em Preto, Vermelho e Laranja.

### Rear disc guard

//The CrossPro Rear Disc Guards, were developed in order to assure extra protection to your motorcycle, preventing the damages.

//The protections were designed to assure:

- Extra protection
- Easy cleaning
- Design Awareness

//Material:

- Aluminum 5mm available in Ice Polish Black
- DTC 15mm available in Black, Red and Orange



Sofia Porfirio

# FOLDING BIKE RAMP

• 2CP083\_

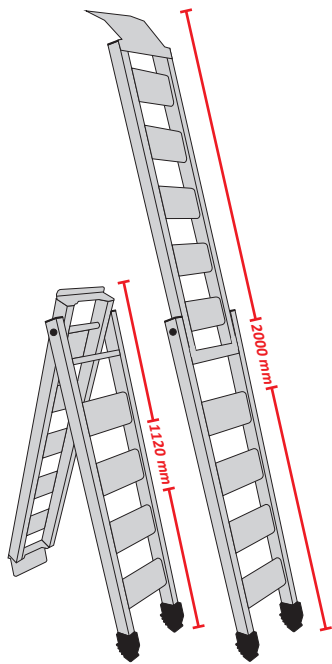

-Supported weight: 240kg  
-Peso suportado: 240kg

- Ice Matte folding bike ramp
- Black folding bike ramp
- White folding bike ramp
- Red folding bike ramp
- Yellow folding bike ramp
- Green folding bike ramp
- Orange folding bike ramp
- Blue folding bike ramp

2CP083001A0001  
2CP083001A0004  
2CP083001A0006  
2CP083001A0007  
2CP083001A0008  
2CP083001A0009  
2CP083001A0010  
2CP083001A0011





- » Replace the (\*\*\*\*) for the code of the desired color Example: Red Color 2CP0730001**0007**
- » Substituir os (\*\*\*\*) pelo código de cor pretendida: Exemplo: para a cor vermelha 2CP0730001**0007**

 »0001	 »0003	 »0004	 »0011	 »0007	 »0006	 »0008	 »0010	 »0009
Ice Matte	Neutral	Black	Blue	Red	White	Yellow	Orange	Green
Ice Polish	Natural	Preto	Azul	Vermelho	Branco	Amarelo	Laranja	Verde

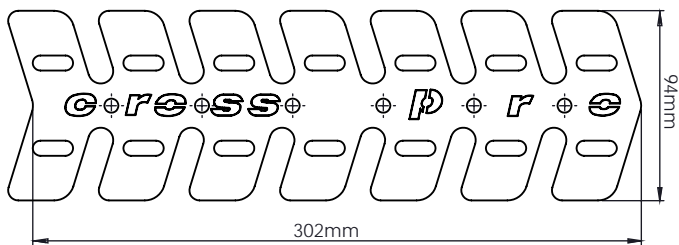

**4-STR**

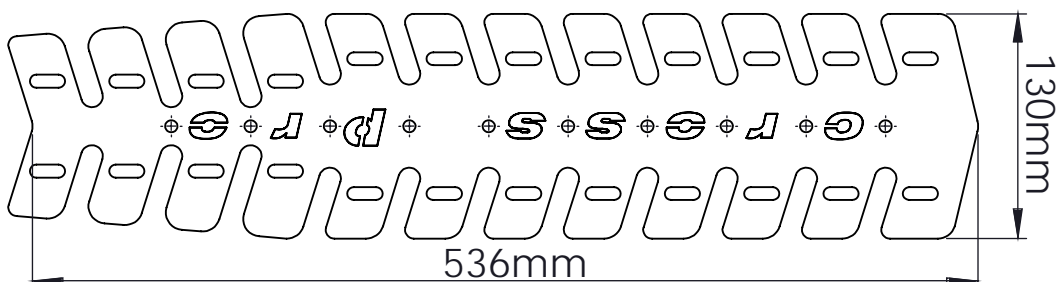

**2-STR**



2CP0730001\*\*\*\*

2 STROKE

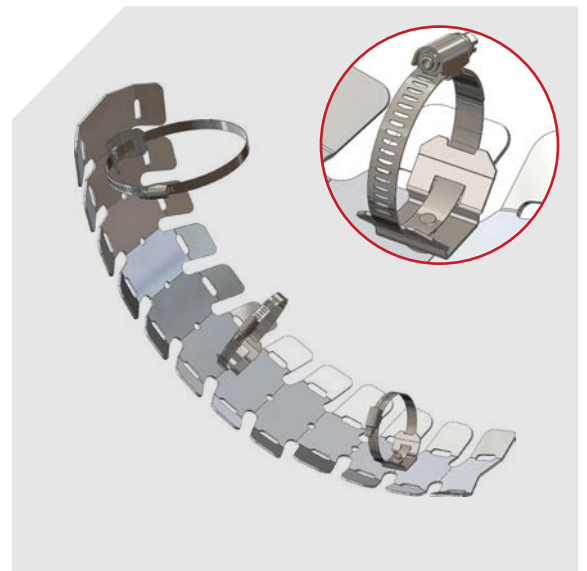

2CP0730005\*\*\*\*

2 STROKE EVO



2CP0730002\*\*\*\*

4 STROKE



2CP0730003\*\*\*\*

4 STROKE

# ALUMINUM EXHAUST PROTECTION

• 2CP073\_

# CARBON EXHAUST PROTECTION



# WASTE DISPOSAL

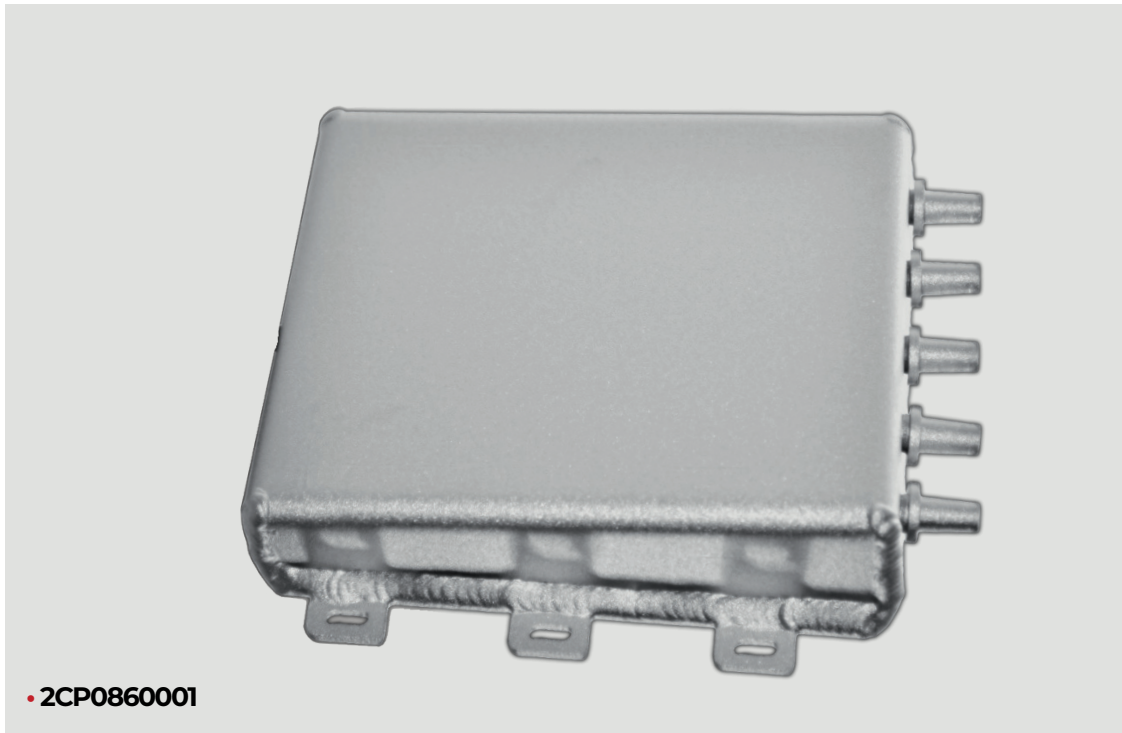

» Replace the (\*\*\*\*) for the code of the desired color Example: Red Color 2CP0860001**0007**

» Substituir os (\*\*\*\*) pelo código de cor pretendida.Exemplo: para a cor vermelha 2CP0860001**0007**

»0001  
Ice Matte  
Ice Polish

»0004  
Black  
Preto

»0011  
Blue  
Azul

»0007  
Red  
Vermelho

»0006  
White  
Branco

»0008  
Yellow  
Amarelo

»0010  
Orange  
Laranja







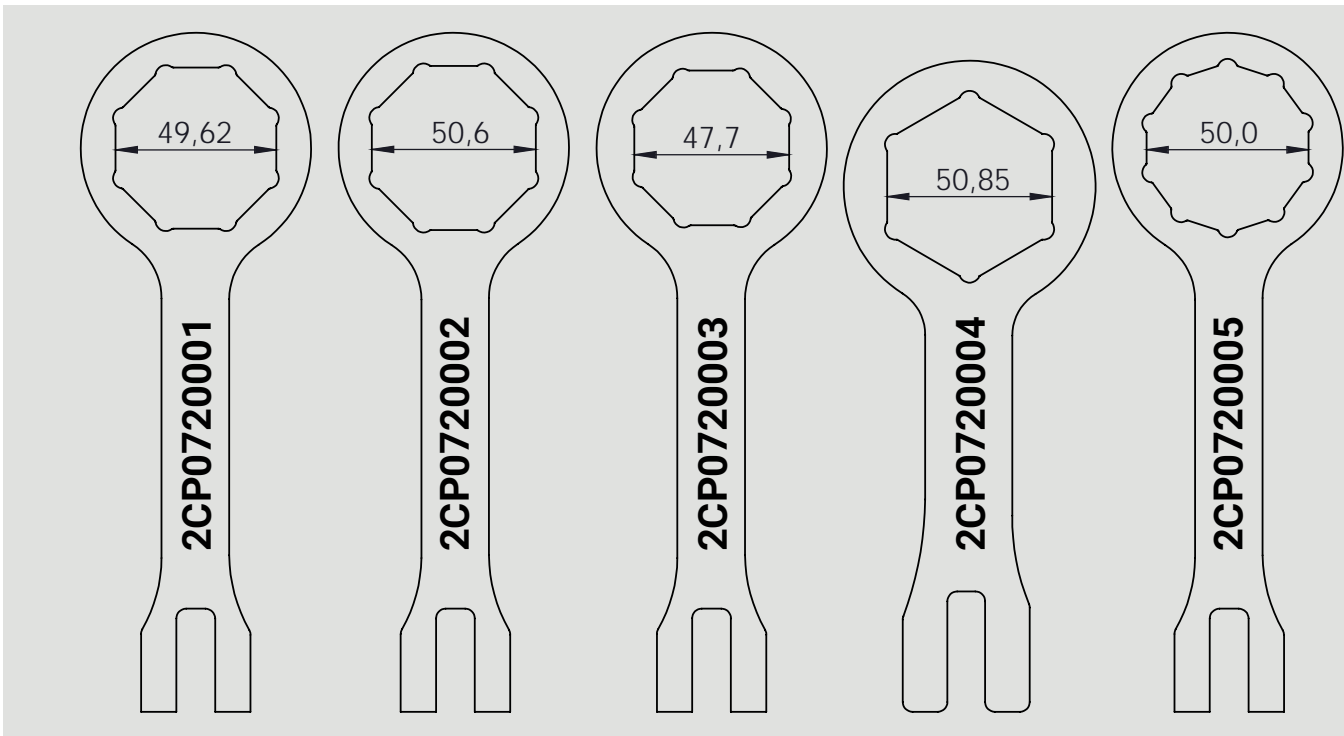

»0009  
Green  
Verde



# FORK WRENCH .2CP072\_



- » Replace the (\*\*\*\*) for the code of the desired color Example: Red Color 2CP0720001\*\*\*\*0007
- » Substituir os (\*\*\*\*) pelo código de cor pretendida Exemplo: para a cor vermelha 2CP0720001\*\*\*\*0007

 »0001	 »0004	 »0011	 »0007	 »0006	 »0008	 »0010	 »0009
Ice Matte	Black	Blue	Red	White	Yellow	Orange	Green
Ice Polish	Preto	Azul	Vermelho	Branco	Amarelo	Laranja	Verde



# HARD XTREME 2.0

• 2CP082\_

## Cavelete HARD XTREME 2.0

- »Construído em aço carbono extremamente resistente
- »Bases reforçadas para maior estabilidade
- »Parte superior e pés em borracha antiderrapante substituíveis.
- »Sistema de elevação otimizado
- »Acabamento em pintura eletrostática para maior durabilidade
- »Design inovador.

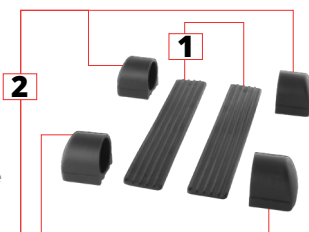

### HARD XTREME 2.0

	CODE
1 Base Rubbers (2un)	2CP0820010A301
2 Foot Rubbers (4un)	2CP0820010A302

## HARD XTREME 2.0 Bike lift

- »Made of extremely durable carbon steel
- »Reinforced bases for better stability
- »Replaceable non-slip rubber upper and feet.
- »Optimized Lifting System
- »Electrostatic paint finish for durability
- »Innovative design.

- Weight / peso: 7,04kg
- Minimum height / altura mínima: 31cm
- Maximum height / altura máxima: 40cm
- Maximum weight / peso máximo: 210kg



• 2CP08200120004



• 2CP08200120006



• 2CP08200120007



• 2CP08200120008



8

• 2CP08200120009

• 2CP08200120010

• 2CP08200120011



# XTREME 16 BIKE STAND

• 2CP082\_

## Cavaletes em ferro

- » Fabricado em aço com proteção superior em borracha anti-derrapante.
- » Topos anti-derrapante.
- » Sistema de elevação com desmultiplicação de esforço.
- » Design inovador.

- » Weight / peso: 5,50kg
- » Minimum height / altura mínima: 30cm
- » Maximum height / altura máxima: 40cm
- » Maximum weight / peso máximo: 140kg

## Iron bike stand

- » Made of steel with Anti-slip rubber protection on the top
- » Anti-slip top
- » Lifting system with less effort
- » Innovative design



• 2CP08200100005



• 2CP08200100006



• 2CP08200100007



• 2CP08200100008



• 2CP08200100009



• 2CP08200100010



• 2CP08200100011

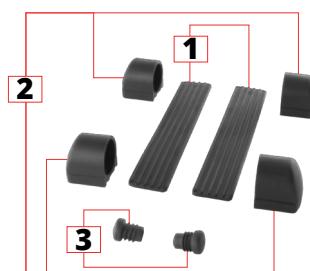

**PARTS**

- 1 Black (2 un)
- 2 Black (4 un)
- 3 Black (2 un)

**SPARE PARTS**

- 2CP0820010A301
- 2CP0820010A302
- 2CP0820010A303

# GRAND PRIX HARD BIKE STAND

• 2CP082\_

## Cavaletes em alumínio

- » Novo Design em diferentes cores
- » Mais resistente
- » Orifício para mudança de óleo
- » Mais Económico

## Aluminum bike stand

- » New Design in different Colors
- » More resistant
- » Hole for Oil Change
- » More Economic

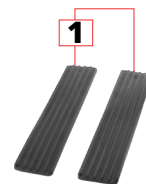

**PARTS**

1 Black (2 un)

**SPARE PARTS**

2CP0820010A301



• 2CP08200110001



• 2CP08200110004



• 2CP08200110005



• 2CP08200110006



• 2CP08200110007



• 2CP08200T10008



• 2CP08200T10009



• 2CP08200T10010



• 2CP08200T10011

» **Protege o mais importante com Crosspro**

A CrossPro oferece uma vasta gama de protecções em alumínio e DTC, da mais elevada qualidade, para proteger a sua moto.

Acessórios como Pára-choques, Nerf Bars e Protecções de chassis constituem o conjunto perfeito para a prática de Todo-o-terreno.

Desenvolvidas com recurso às melhores matérias-primas e com suporte das melhores técnicas de produção, as protecções CrossPro são uma peça fundamental para usufruir ao máximo da sua moto.

Ride and enjoy it

» **Protect the important with CrossPro**

The CrossPro offer you a wide range of aluminum and DTC protections, with highest quality, to protect your bike.

Accessories such as Bumpers, Nerf Bars and Chassis Protectors are the perfect set for the practice of all-terrain. Developed using the best raw materials and with support of improved production techniques, the CrossPro protections are essential to enjoy the most with your bike.

Ride and enjoy it

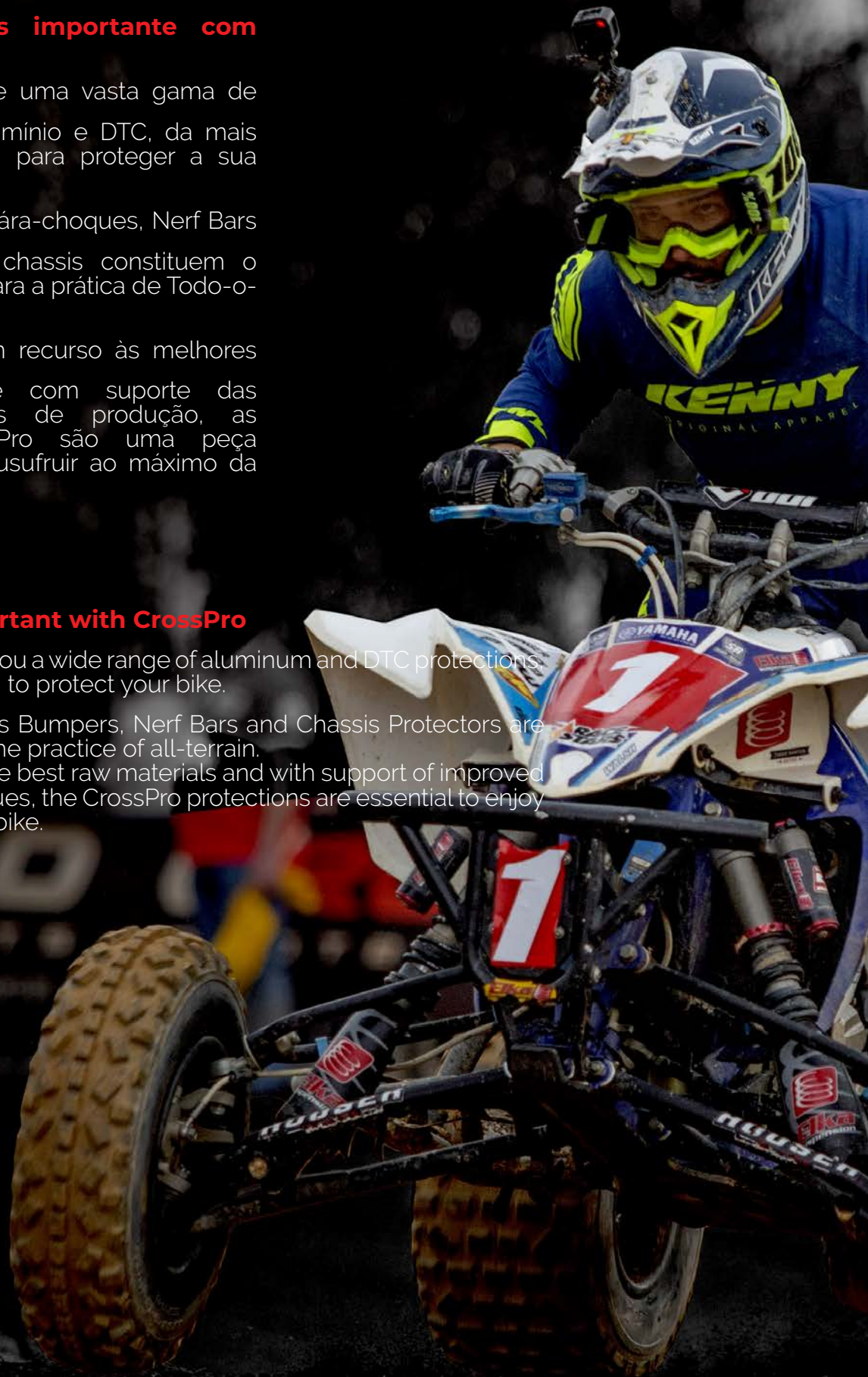





sports  
quad  
racing  
protection



# **FRONT BUMPERS**





# FRONT BUMPER CR01

•2CP229A\_ (front tube)



•2CP229A\_0001



•2CP229A\_0002



•2CP229A\_0004



•2CP229A\_0005



•2CP229A\_0006



•2CP229A\_0007



•2CP229A\_0008



•2CP229A\_0009



•2CP229A\_0010



•2CP229A\_0011

# 60

## COMBINABLE COLORS CORES COMBINÁVEIS

• **2CP229\_** (Complete front bumper)



• **2CP229A0000\_** (Universal front plate)



• **2CP229A0000300**



• **2CP229A0000400**



• **2CP229A0000500**



• **2CP229A0000600**



• **2CP229A0000700**



• **2CP229A0000900**

- » Design Atraente e Inovador
- » Pára-Choques perfeito para competição ou lazer
- » Soldado com tecnologia TIG
- » Leveza e Máxima Resistência
- » BAS (Bumper Adjustment System) - novo sistema de fixação que permite o ajuste em altura e em inclinação do Pára-Choques
- » Sistema testado em competição
- » Fácil Montagem
- » Elevada resistência ao Impacto

- » Innovative design
- » Perfect Bumper for Racing or Recreation
- » All Precision TIG Welded
- » Light weight and Maximum Resistance
- » BAS (Bumpers Adjustment System), a new fitting system that allows the adjustment in depth, height and frontal angle of each Bumper
- » System tested in competition
- » Easy to mount
- » High resistance to impact

# FRONT BUMPER CRO2

- »Design Atraente e Inovador
- »Pára-Choques perfeito para competição ou lazer
- »Soldado com tecnologia TIG
- »Leveza e Máxima Resistência
- »BAS (Bumper Adjustment System) – novo sistema de fixação que permite o ajuste em altura e em inclinação do Pára-Choques
- »Sistema testado em competição
- »Fácil Montagem
- »Elevada resistência ao Impacto

- »Innovative design
- »Perfect Bumper for Racing or Recreation
- »All Precision TIG Welded
- »Light weight and Maximum Resistance
- »BAS (Bumpers Adjustment System), a new fitting system that allows the adjustment in depth, height and frontal angle of each Bumper
- »System tested in competition
- »Easy to mount
- »High resistance to impact



• 2CP230A\_ (front tube)



• 2CP230A\_0001



• 2CP230A\_0002



• 2CP230A\_0004



• 2CP230A\_0005



• 2CP230A\_0006



• 2CP230A\_0007



• 2CP230A\_0008



• 2CP230A\_0009



• 2CP230A\_0010



• 2CP230A\_0011



# 60 COMBINABLE COLORS CORES COMBINÁVEIS

• 2CP229A0000\_ (Universal front plate)



• 2CP229A0000300



• 2CP229A0000400



• 2CP229A0000500



• 2CP229A0000600



• 2CP229A0000700



• 2CP229A0000900



# FRONT BUMPER CR03

•2CP231A\_ (front tube)



•2CP231A\_\_0001



•2CP231A\_\_0002



•2CP231A\_\_0004



•2CP231A\_\_0005



•2CP231A\_\_0006



•2CP231A\_\_0007



•2CP231A\_\_0008



•2CP231A\_\_0009



•2CP231A\_\_0010



•2CP231A\_\_0011



# 60

## COMBINABLE COLORS CORES COMBINÁVEIS

### • 2CP231\_ (Complete front bumper)



### • 2CP231A0000\_ (Universal front plate)

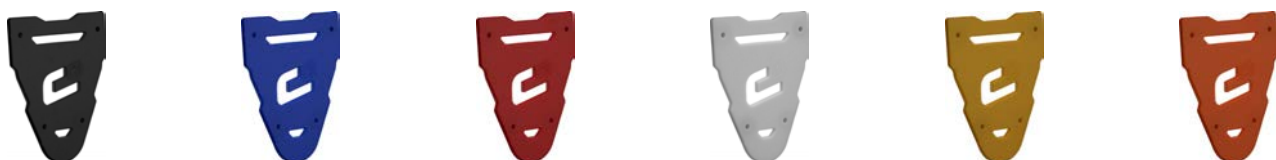

• 2CP231A0000300

• 2CP231A0000400

• 2CP231A0000500

• 2CP231A0000600

• 2CP231A0000700

• 2CP231A0000900

- »Design Atraente e Inovador
- »Pára-Choques perfeito para competição ou lazer
- »Soldado com tecnologia TIG
- »Leveza e Máxima Resistência
- »BAS (Bumper Adjustment System) – novo sistema de fixação que permite o ajuste em altura e em inclinação do Pára-Choques
- »Sistema testado em competição
- »Fácil Montagem
- »Elevada resistência ao Impacto

- »Innovative design
- »Perfect Bumper for Racing or Recreation
- »All Precision TIG Welded
- »Light weight and Maximum Resistance
- »BAS (Bumpers Adjustment System), a new fitting system that allows the adjustment in depth, height and frontal angle of each Bumper
- »System tested in competition
- »Easy to mount
- »High resistance to impact

60

COMBINABLE COLORS  
CORES COMBINÁVEIS

# FRONT BUMPER CR04

• 2CP232A0000\_ (Universal front plate)



• 2CP232A0000300



• 2CP232A0000400



• 2CP232A0000500



• 2CP232A0000600



• 2CP232A0000700



• 2CP232A0000900



- »Design Atraente e Inovador
- »Pára-Choques perfeito para competição ou lazer
- »Soldado com tecnologia TIG
- »Leveza e Máxima Resistência
- »BAS (Bumper Adjustment System) – novo sistema de fixação que permite o ajuste em altura e em inclinação do Pára-Choques
- »Sistema testado em competição
- »Fácil Montagem
- »Elevada resistência ao Impacto

- »Innovative design
- »Perfect Bumper for Racing or Recreation
- »All Precision TIG Welded
- »Light weight and Maximum Resistance
- »BAS (Bumpers Adjustment System), a new fitting system that allows the adjustment in depth, height and frontal angle of each Bumper
- »System tested in competition
- »Easy to mount
- »High resistance to impact

• **2CP232\_** (Complete front bumper)



• **2CP232A\_** (front tube)













# FRONT BUMPER P-SERIES

- »Design Standard
- »Extremamente Leve
- »Placa Frontal Ventilada
- »Máxima Protecção
- »Tubo de alumínio de elevada resistência (T6061) - 35mm
- »Soldado a TIG para extra durabilidade
- »Testado em competição
- »Pára-Choques Perfeito para QX

- »Standard Design
- »Extremely light
- »Vented Frontal Plate
- »Maximum protection
- »Strong aluminum tubing (T6061) - 35mm
- »Tig welded for extra strength
- »Race tested and proved
- »Perfect for MX Racing

» Replace the (\*\*\*\*) for the code of the desired color Example: Red Color 2CP0160001**0007**

» Substituir os (\*\*\*\*) pelo código de cor pretendida:Exemplo: para a cor vermelha 2CP0160001**0007**

 »0001	 »0002	 »0004	 »0005	 »0006	 »0007	 »0008	 »0009	 »0010	 »0011
Ice Matte Ice Polish	Polish Polido	Black Preto	Textured Black Preto Texturado	White Branco	Red Vermelho	Yellow Amarelo	Green Verde	Orange Laranja	Blue Azul

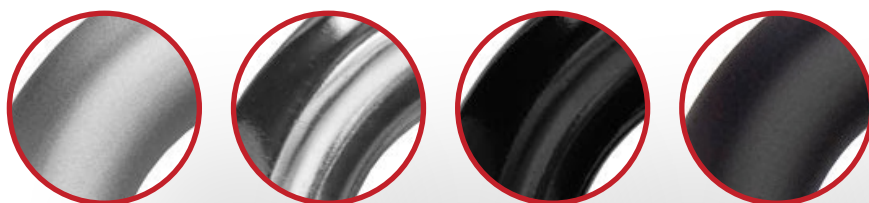



**P21**  
•2CP016\_



**P25**  
•2CP017\_



**P30**  
•2CP018\_



**P35**  
•2CP019\_

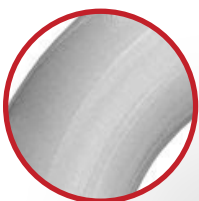

# FRONT BUMPER WASP LITE



- »Design Atraente e Inovador
- »Pára-Choques perfeito para competição ou lazer
- »Soldado com tecnologia TIG
- »Leveza e Máxima Resistência
- »BAS (Bumper Adjustment System) - novo sistema de fixação que permite o ajuste em altura e em inclinação do Pára-Choques
- »Sistema testado em competição
- »Fácil Montagem
- »Elevada resistência ao Impacto

- »Innovative design
- »Perfect Bumper for Racing or Recreation
- »All Precision TIG Welded
- »Light weight and Maximum Resistance
- »BAS (Bumpers Adjustment System), a new fitting system that allows the adjustment in depth, height and frontal angle of each Bumper
- »System tested in competition
- »Easy to mount
- »High resistance to impact

## • 2CP037\_ (Specific fixation)



## • 2CP028\_ (Universal front tube)



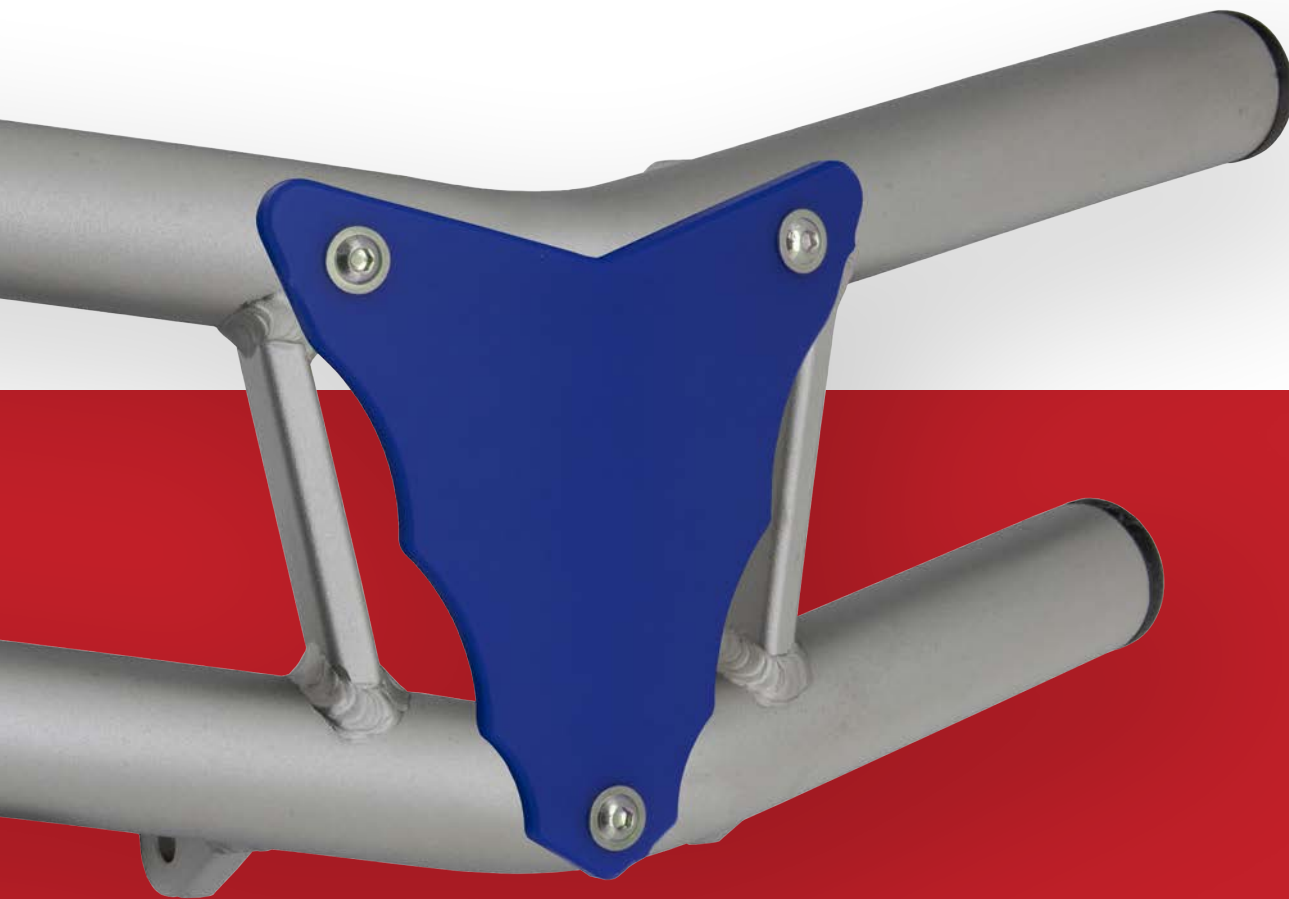

# 60 COMBINABLE COLORS CORES COMBINÁVEIS



• 2CP033\_ (Universal front plate)





# FRONT BUMPER WASPE



• 2CP028\_ (Universal front tube)



• 2CP02800000001



• 2CP02800000002



• 2CP02800000004



• 2CP02800000005



• 2CP02800000006



• 2CP02800000007



• 2CP02800000008



• 2CP02800000009



• 2CP02800000010



• 2CP02800000011



• **2CP024\_** (Complete front bumper)



# 60

COMBINABLE COLORS  
CORES COMBINÁVEIS

• **2CP037\_** (Specific fixation)

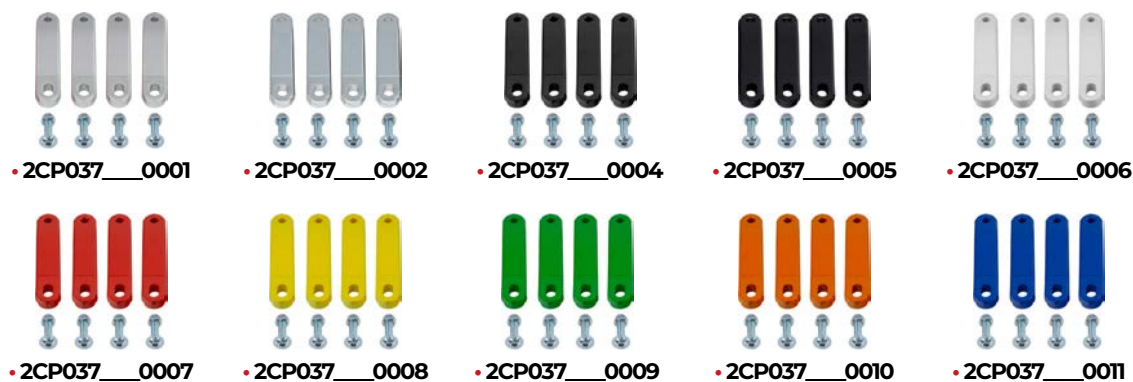

• **2CP034\_** (Universal front plate)

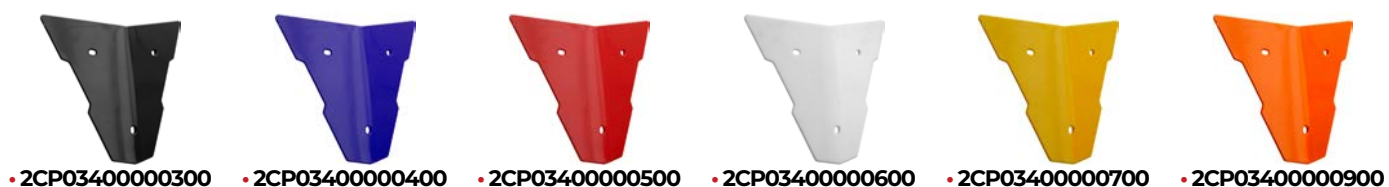

»Design Atraente e Inovador  
 »Pára-Choques perfeito para competição ou lazer  
 »Soldado com tecnologia TIG  
 »Leveza e Máxima Resistência  
 »BAS (Bumper Adjustment System) – novo sistema de fixação que permite o ajuste em altura e em inclinação do Pára-Choques  
 »Sistema testado em competição  
 »Fácil Montagem  
 »Elevada resistência ao Impacto

»Innovative design  
 »Perfect Bumper for Racing or Recreation  
 »All Precision TIG Welded  
 »Light weight and Maximum Resistance  
 »BAS (Bumpers Adjustment System), a new fitting system that allows the adjustment in depth, height and frontal angle of each Bumper  
 »System tested in competition  
 »Easy to mount  
 »High resistance to impact

# FRONT BUMPER GLIESE

• **2CP022\_** (Complete front bumper)



**60**  
COMBINABLE COLORS  
CORES COMBINÁVEIS



• **2CP037\_** (Specific fixation)

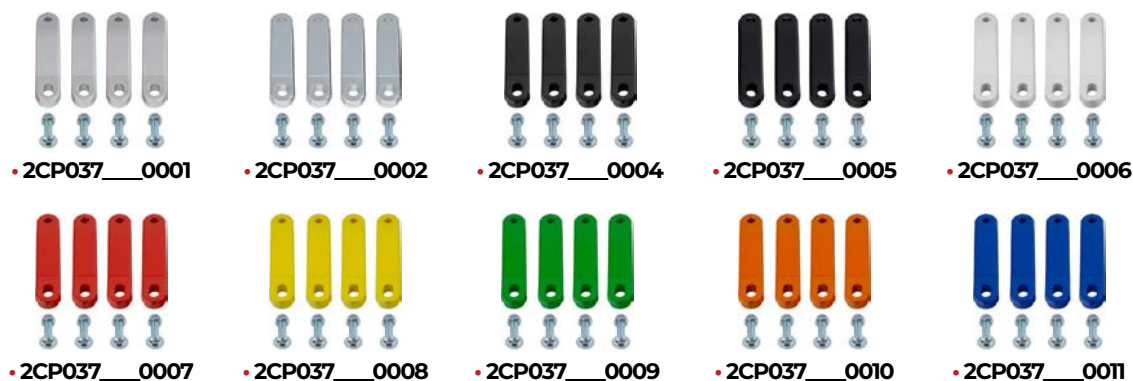

• **2CP027\_ (Universal front tube)**



• **2CP02700000001**

• **2CP02700000002**

• **2CP02700000004**

• **2CP02700000005**

• **2CP02700000006**



• **2CP02700000007**

• **2CP02700000008**

• **2CP02700000009**

• **2CP02700000010**

• **2CP02700000011**

• **2CP032\_ (Universal front plate)**



• **2CP03200000300**

• **2CP03200000400**

• **2CP03200000500**

• **2CP03200000600**

• **2CP03200000700**

• **2CP03200000900**

- »Design Atraente e Inovador
- »Pára-Choques perfeito para competição ou lazer
- »Soldado com tecnologia TIG
- »Leveza e Máxima Resistência
- »BAS (Bumper Adjustment System) – novo sistema de fixação que permite o ajuste em altura e em inclinação do Pára-Choques
- »Sistema testado em competição
- »Fácil Montagem
- »Elevada resistência ao Impacto

- »Innovative design
- »Perfect Bumper for Racing or Recreation
- »All Precision TIG Welded
- »Light weight and Maximum Resistance
- »BAS (Bumpers Adjustment System), a new fitting system that allows the adjustment in depth, height and frontal angle of each Bumper
- »System tested in competition
- »Easy to mount
- »High resistance to impact



# FRONT BUMPER

# HAT



- »Design Atraente e Inovador
- »Pára-Choques perfeito para competição ou lazer
- »Soldado com tecnologia TIG
- »Leveza e Máxima Resistência
- »BAS (Bumper Adjustment System) – novo sistema de fixação que permite o ajuste em altura e em inclinação do Pára-Choques
- »Sistema testado em competição
- »Fácil Montagem
- »Elevada resistência ao Impacto

- »Innovative design
- »Perfect Bumper for Racing or Recreation
- »All Precision TIG Welded
- »Light weight and Maximum Resistance
- »BAS (Bumpers Adjustment System), a new fitting system that allows the adjustment in depth, height and frontal angle of each Bumper
- »System tested in competition
- »Easy to mount
- »High resistance to impact

## • 2CP037\_ (Specific fixation)



## • 2CP030\_ (Universal front tube)



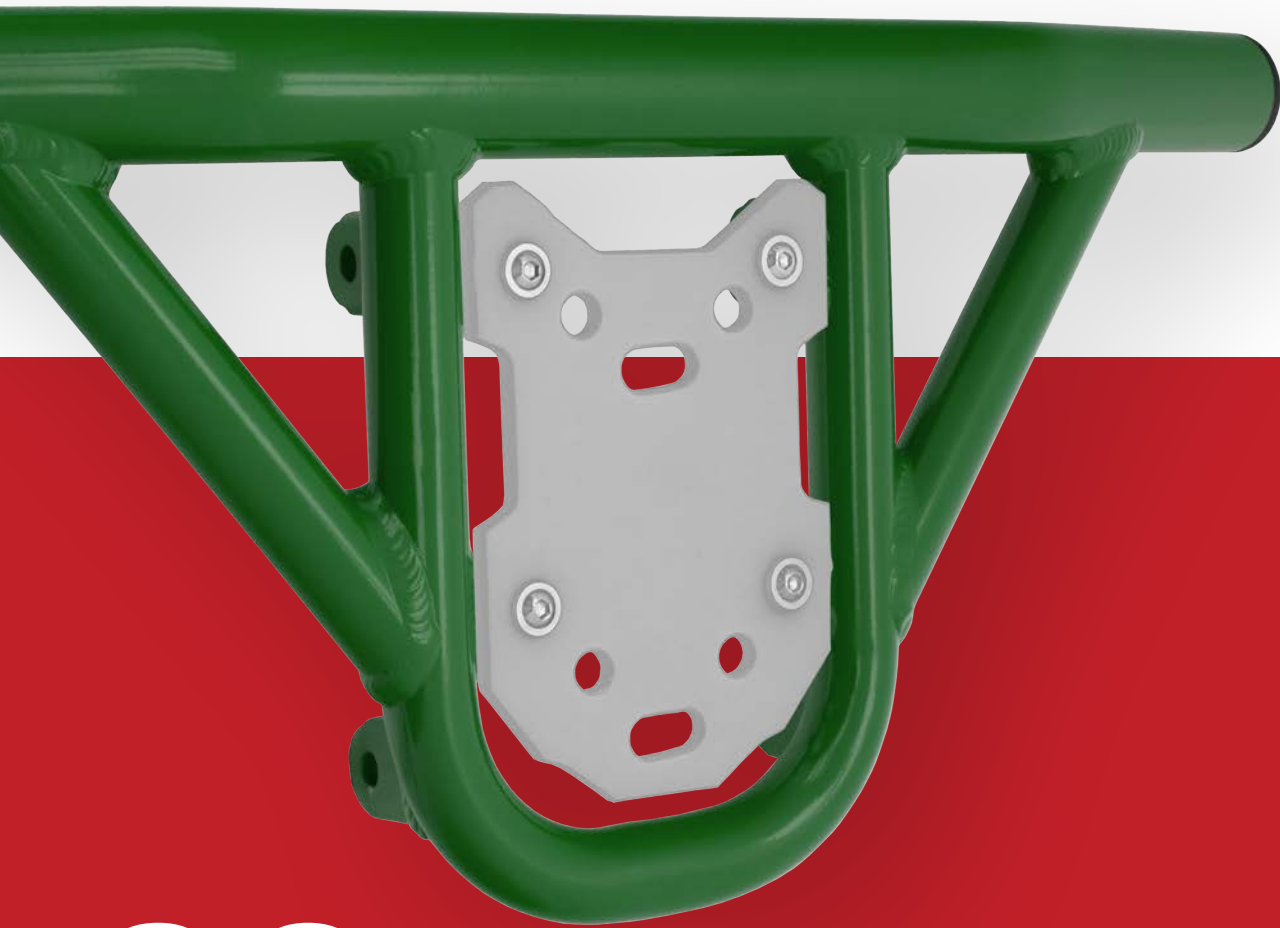

# 60 COMBINABLE COLORS CORES COMBINÁVEIS



• 2CP035\_ (Universal front plate)





# FRONT BUMPER COROT



• 2CP031L (Universal front tube)



• 2CP03100000001



• 2CP03100000002



• 2CP03100000004



• 2CP03100000005



• 2CP03100000006



• 2CP03100000007



• 2CP03100000008



• 2CP03100000009



• 2CP03100000010



• 2CP03100000011



• **2CP026\_** (Complete front bumper)



# 60

## COMBINABLE COLORS

## CORES COMBINÁVEIS

• **2CP037\_** (Specific fixation)

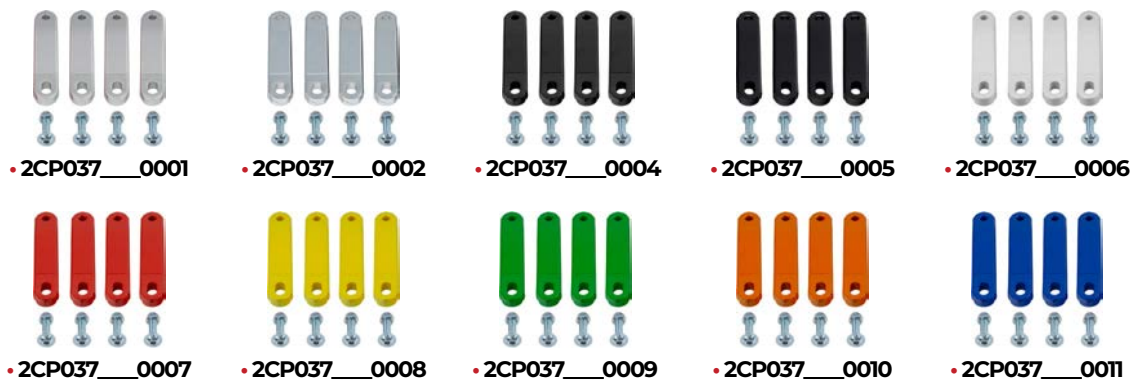

• **2CP033\_** (Universal front plate)



- » Design Atraente e Inovador
- » Pára-Choques perfeito para competição ou lazer
- » Soldado com tecnologia TIG
- » Leveza e Máxima Resistência
- » BAS (Bumper Adjustment System) – novo sistema de fixação que permite o ajuste em altura e em inclinação do Pára-Choques
- » Sistema testado em competição
- » Fácil Montagem
- » Elevada resistência ao Impacto

- » Innovative design
- » Perfect Bumper for Racing or Recreation
- » All Precision TIG Welded
- » Light weight and Maximum Resistance
- » BAS (Bumpers Adjustment System), a new fitting system that allows the adjustment in depth, height and frontal angle of each Bumper
- » System tested in competition
- » Easy to mount
- » High resistance to impact



# NERF-BARS







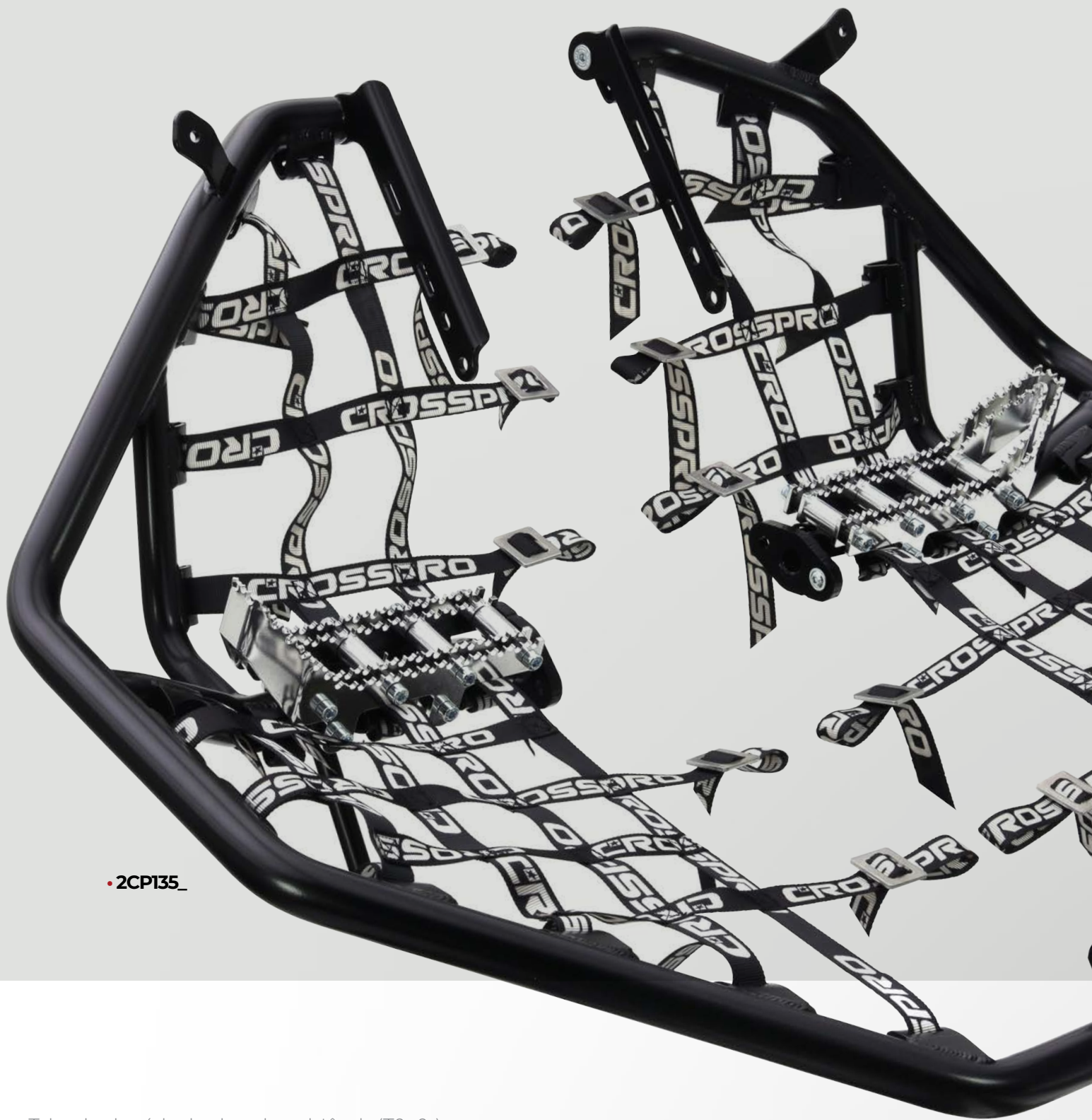

• 2CP135\_

»Tubo de alumínio de elevada resistência (T6061) – 35mm  
»Soldado a TIG para extra durabilidade  
»Perfeito para Lazer ou competição



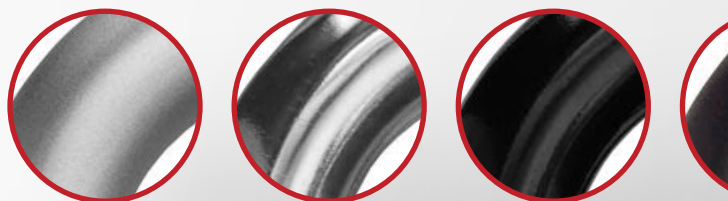







»Aluminum tube (T6061)- 35mm for high resistance  
»TIG welded for extra strength  
»Perfect for recreation or competition



# HARD RACING NERF-BAR



- > Replace the (\*\*\*\*) for the code of the desired color Example: Red Color 2CP1350001**0007**
- > Substituir os (\*\*\*\*) pelo código de cor pretendida: Exemplo: para a cor vermelha 2CP1350001**0007**

 »0001	 »0002	 »0004	 »0005	 »0006	 »0007	 »0008	 »0009	 »0010	 »0011
Ice Matte Ice Polish	Polish Polido	Black Preto	Textured Black Preto Texturado	White Branco	Red Vermelho	Yellow Amarelo	Green Verde	Orange Laranja	Blue Azul

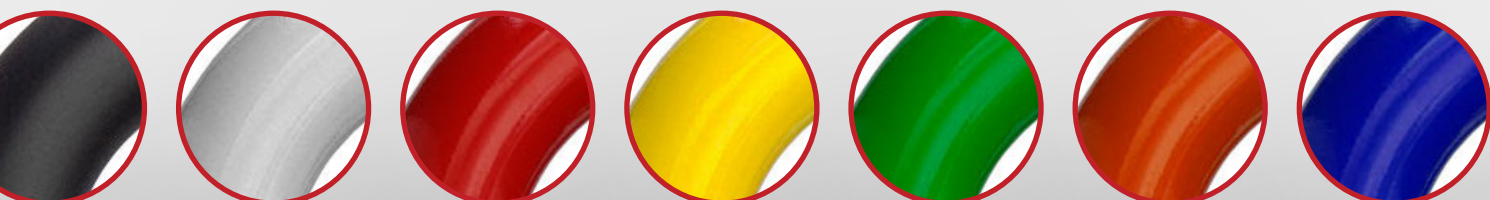

# NERF-BAR RACING PRO













- »Tubo de alumínio de elevada resistência (T6061) – 35mm
- »Soldado a TIG para extra durabilidade
- »Perfeito para Lazer ou competição

- »Aluminum tube (T6061)- 35mm for high resistance
- »TIG welded for extra strength
- »Perfect for recreation or competition

» Replace the (\*\*\*\*) for the code of the desired color Example: Red Color 2CP0060001**0007**

» Substituir os (\*\*\*\*) pelo código de cor pretendida:Exemplo: para a cor vermelha 2CP0060001**0007**

 »0001	 »0002	 »0004	 »0005	 »0006	 »0007	 »0008	 »0009	 »0010	 »0011
Ice Matte Ice Polish	Polish Polido	Black Preto	Textured Black Preto Texturado	White Branco	Red Vermelho	Yellow Amarelo	Green Verde	Orange Laranja	Blue Azul

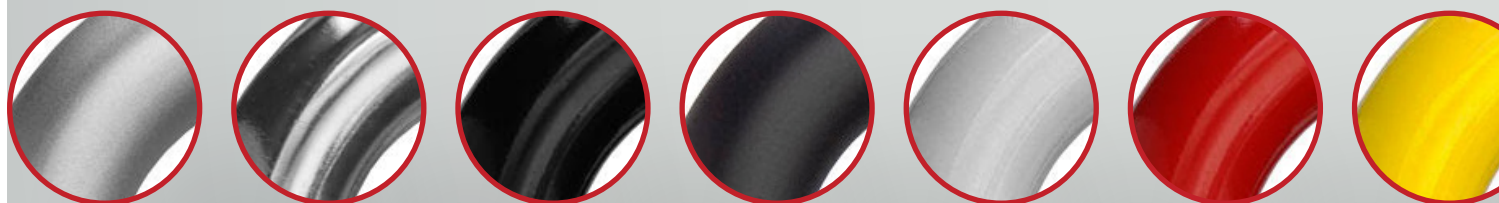

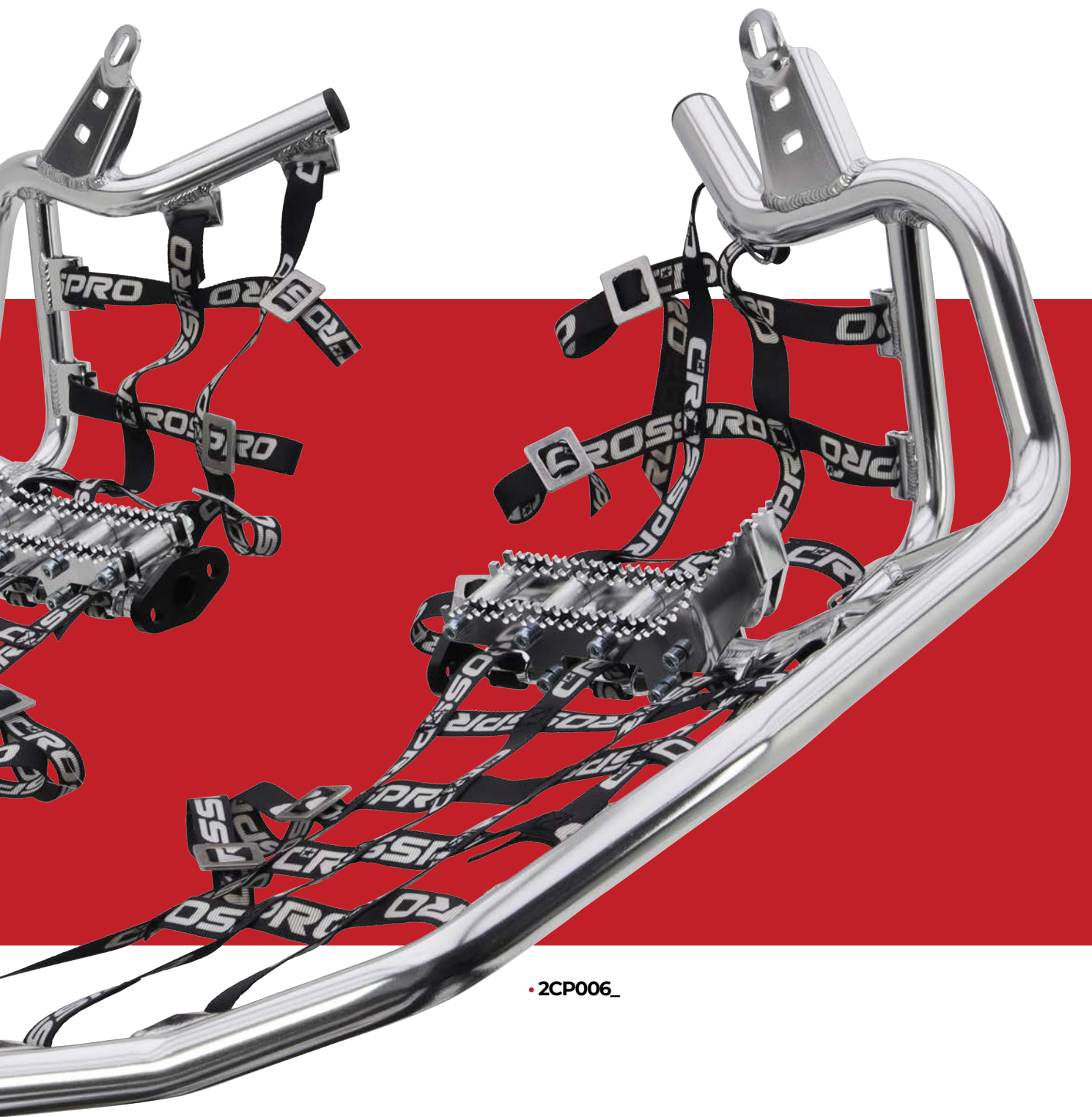

• 2CP006\_





• 2CP005\_











»Tubo de alumínio de elevada resistência (T6061) – 35mm  
 »Soldado a TIG para extra durabilidade  
 »Perfeito para Lazer ou competição

»Aluminum tube (T6061)- 35mm for high resistance  
 »TIG welded for extra strength  
 »Perfect for recreation or competition

# NERF-BAR EVO PRO

» Replace the (\*\*\*\*) for the code of the desired color Example: Red Color 2CP0050001**0007**

» Substituir os (\*\*\*\*) pelo código de cor pretendida:Exemplo: para a cor vermelha 2CP0050001**0007**

 »0001	 »0002	 »0004	 »0005	 »0006	 »0007	 »0008	 »0009	 »0010	 »0011
Ice Matte Ice Polish	Polish Polido	Black Preto	Textured Black Preto Texturado	White Branco	Red Vermelho	Yellow Amarelo	Green Verde	Orange Laranja	Blue Azul

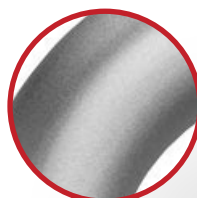

# NERF-BAR

# ECO PRO

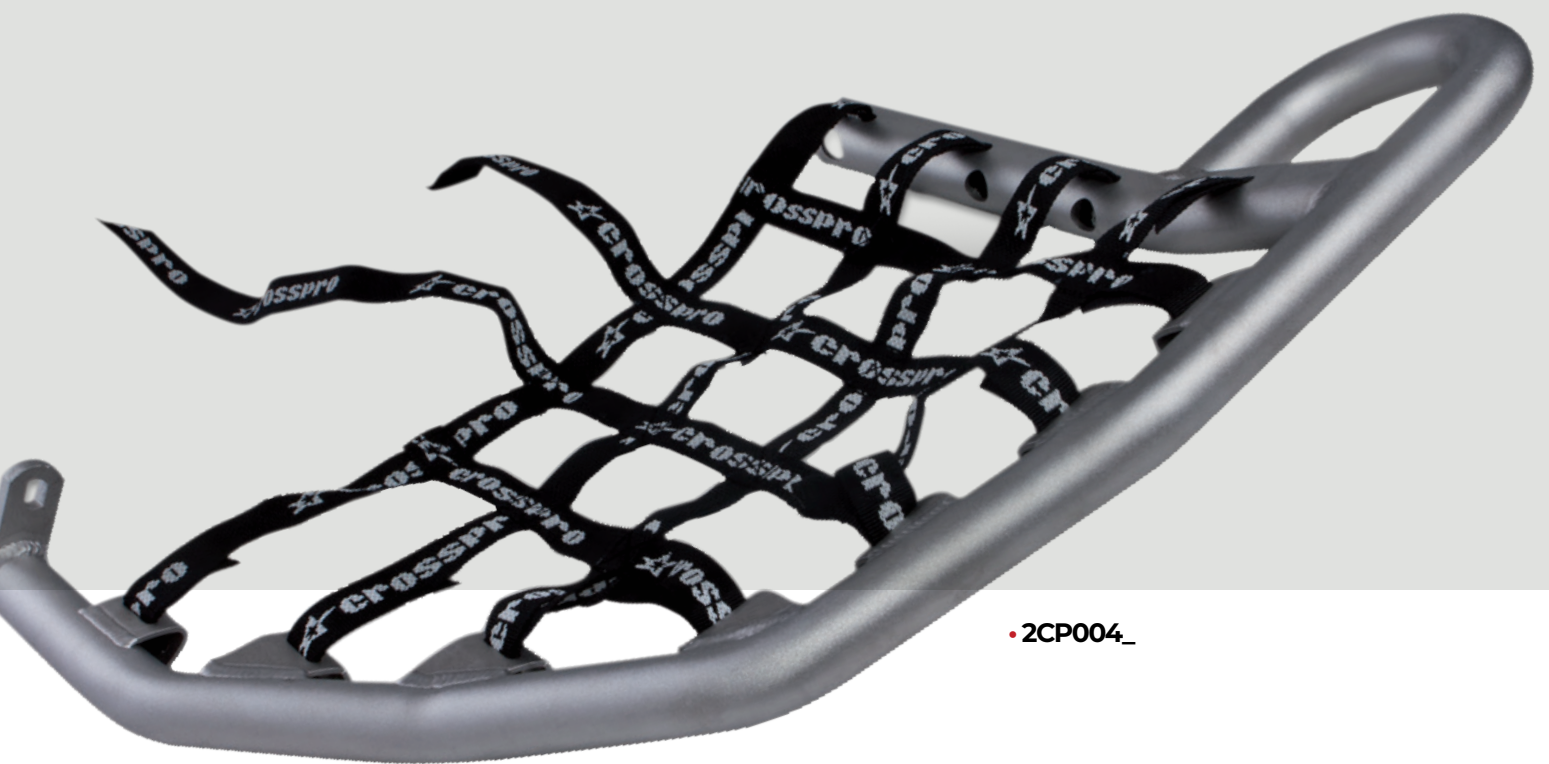

•2CP004\_

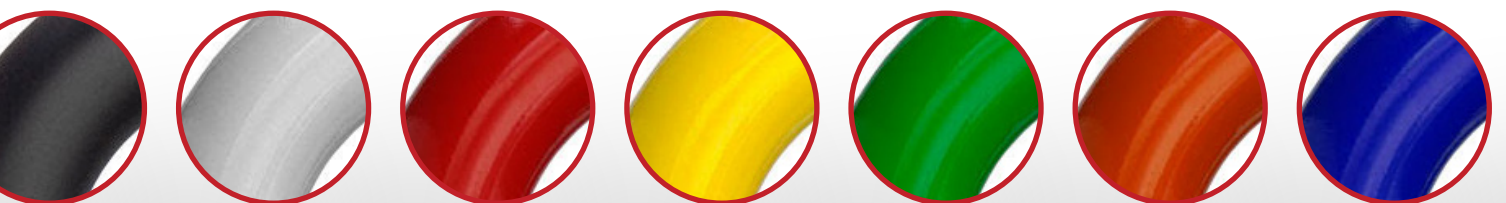

# NERF-BARS

# FIRST STEPS

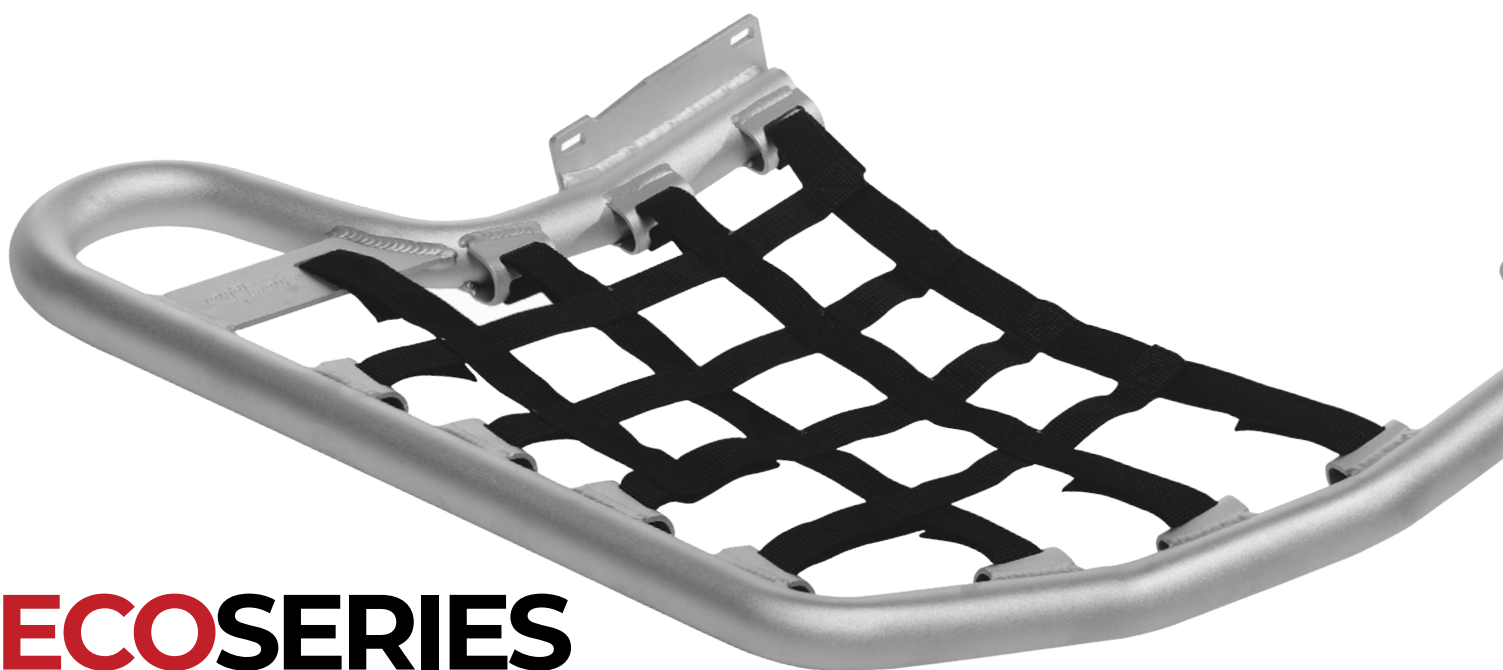

**ECOSERIES**  
•2CP00L

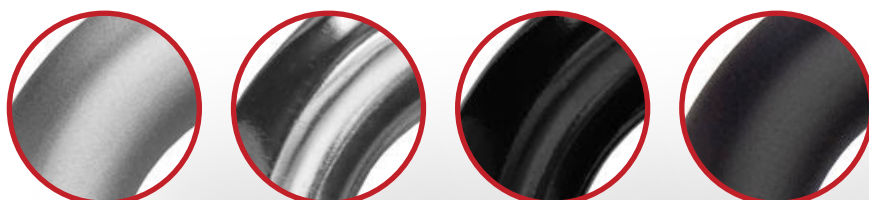





# EVO1











•2CP002\_

»Tubo de alumínio de elevada resistência (T6061) – 35mm  
 »Soldado a TIG para extra durabilidade  
 »Perfeito para Lazer ou competição

»Aluminum tube (T6061)- 35mm for high resistance  
 »TIG welded for extra strength  
 »Perfect for recreation or competition

» Replace the (\*\*\*\*) for the code of the desired color Example: Red Color 2CP0010001**0007**

» Substituir os (\*\*\*\*) pelo código de cor pretendida:Exemplo: para a cor vermelha 2CP0010001**0007**

 »0001	 »0002	 »0004	 »0005	 »0006	 »0007	 »0008	 »0009	 »0010	 »0011
Ice Matte Ice Polish	Polish Polido	Black Preto	Textured Black Preto Texturado	White Branco	Red Vermelho	Yellow Amarelo	Green Verde	Orange Laranja	Blue Azul

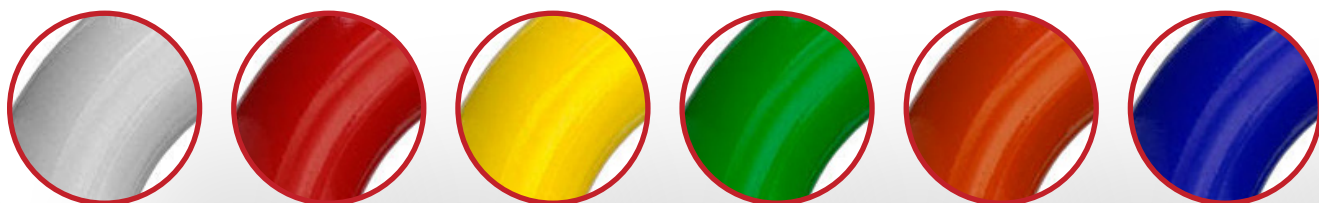



## **FOOT PEGS**

•2CP014\_

# **NERF-BARS ACCESSÓRIES**



## **HEEL PROTECTION**

•2CP012\_



# UNIVERSAL FOOT PEGS

• 2CP014000000\_

# NERF-BAR BELTS

• 2CP14L

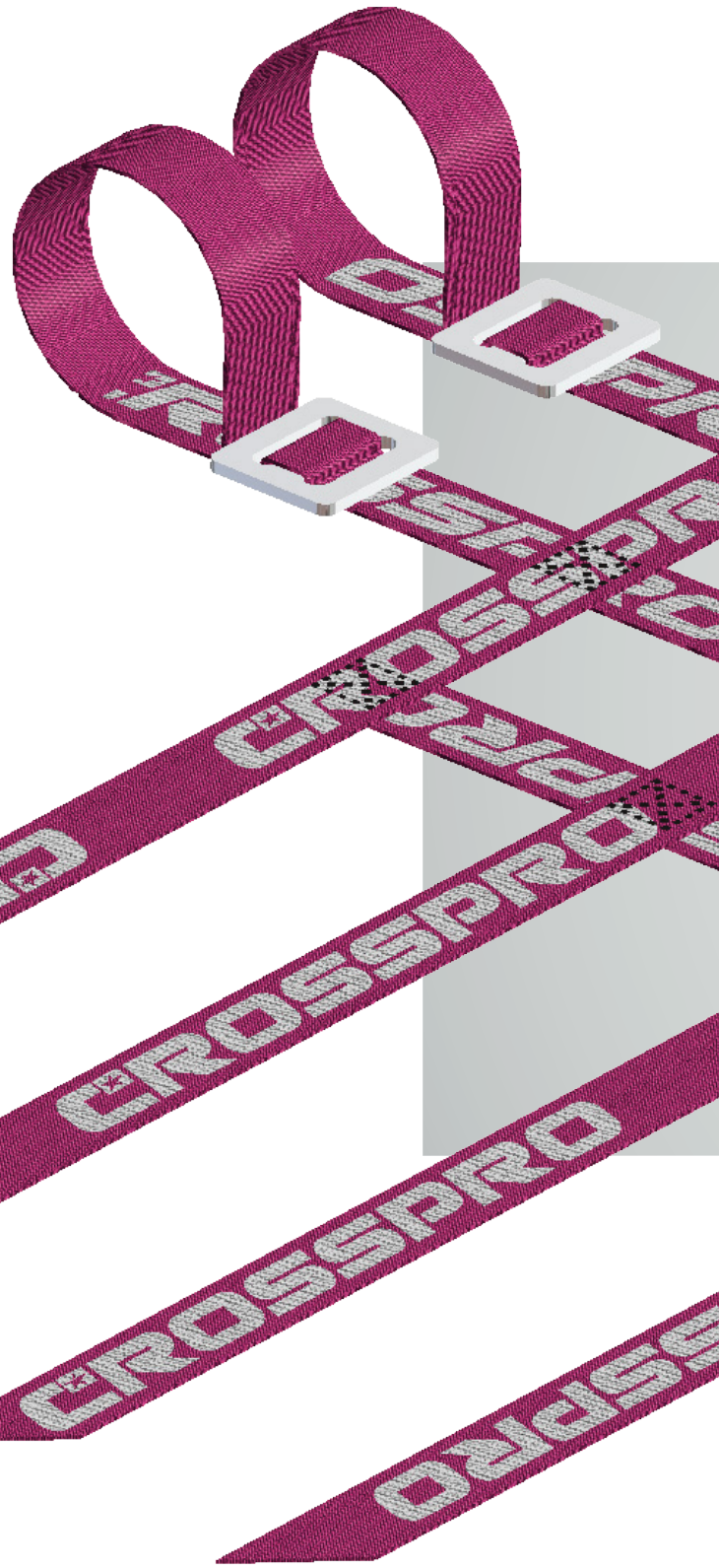

» Replace the (\*\*\*\*) for the code of the desired color Example: Red Color 2CP0060001**0007**

» Substituir os (\*\*\*\*) pelo código de cor pretendida:Exemplo: para a cor vermelha 2CP0060001**0007**

 »0004	 »0007	 »0008	 »0009	 »0010	 »0011	 »0011
Black Preto	Red Vermelho	Yellow Amarelo	Green Verde	Orange Laranja	Blue Azul	Pink Rosa



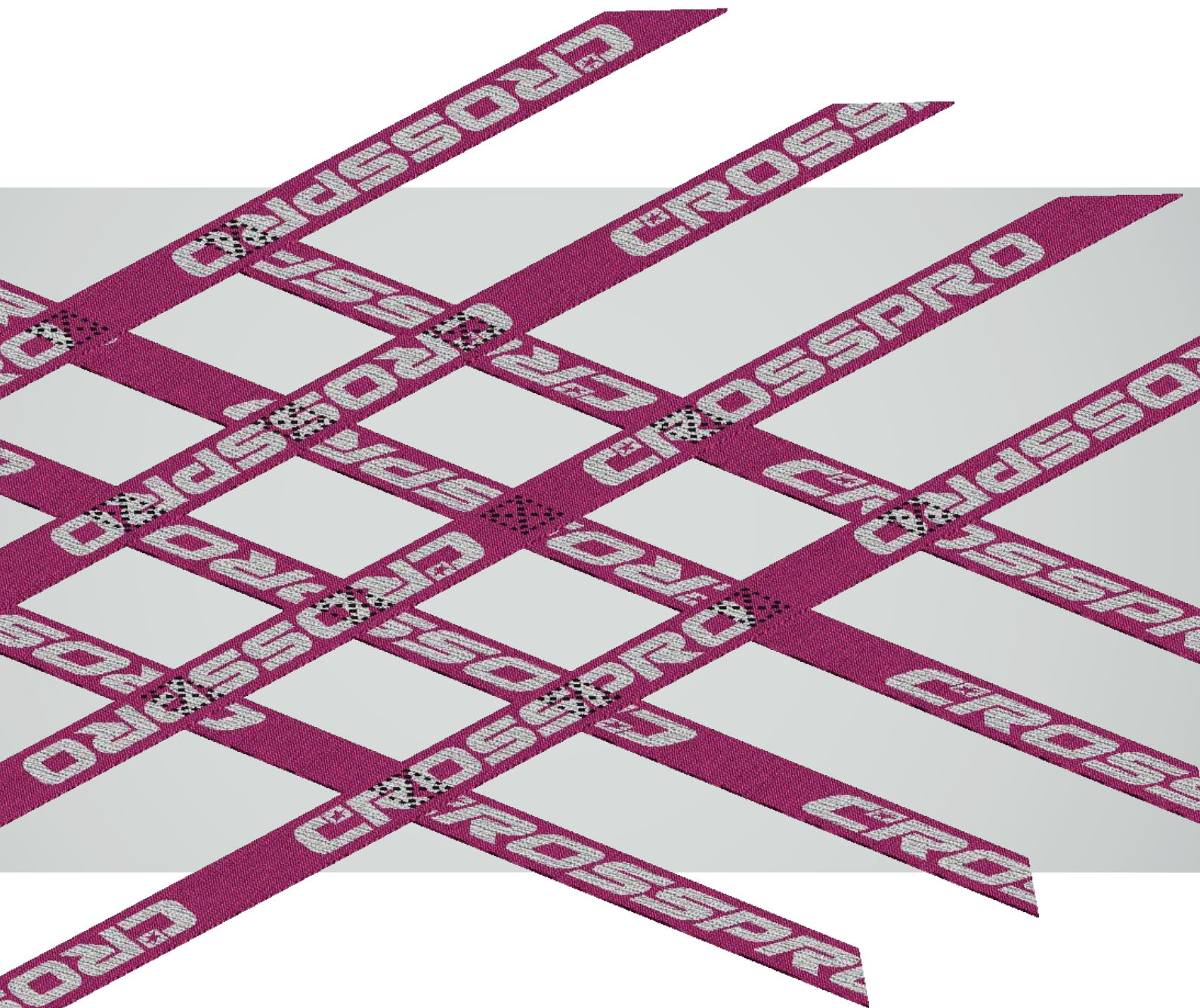

•2CP01412120\_



•2CP01412320\_

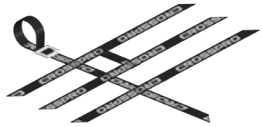

•2CP01413130\_



•2CP01413230\_

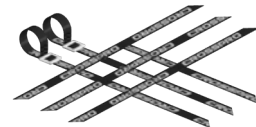

•2CP01413330\_

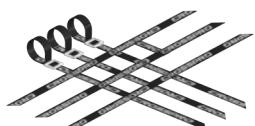

•2CP0141333A\_

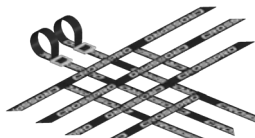

•2CP01413340\_

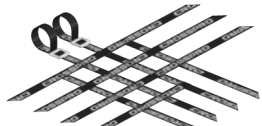

•2CP01413440\_

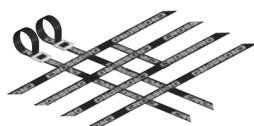

•2CP01414240\_

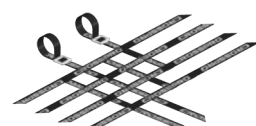

•2CP0141424A\_

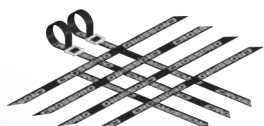

•2CP01414340\_

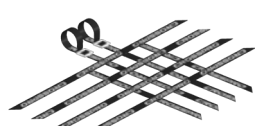

•2CP01414440\_



•2CP10800010000



# PROTECTION QUAD

»Produzido com alumínio da mais alta qualidade (T6061), as protecções da CrossPro são fabricada com 4mm de espessura o que combina leveza com a máxima resistência

»O seu ATV ficará completamente protegido contra o impacto de pedras, paus ou outros objectos que podem causar danos irreversíveis

»Repuxado na zona de fixação dos parafusos, eliminando quaisquer problemas de fixação

»Produced in high quality T6061 aluminum, CrossPro protections have 4mm thickness, which combines Lightweight with maximum protection

»Your atv will be completely protected against rock impacts that can destroy your engine

»Spun in the fixing screws area, eliminates any fixing problems

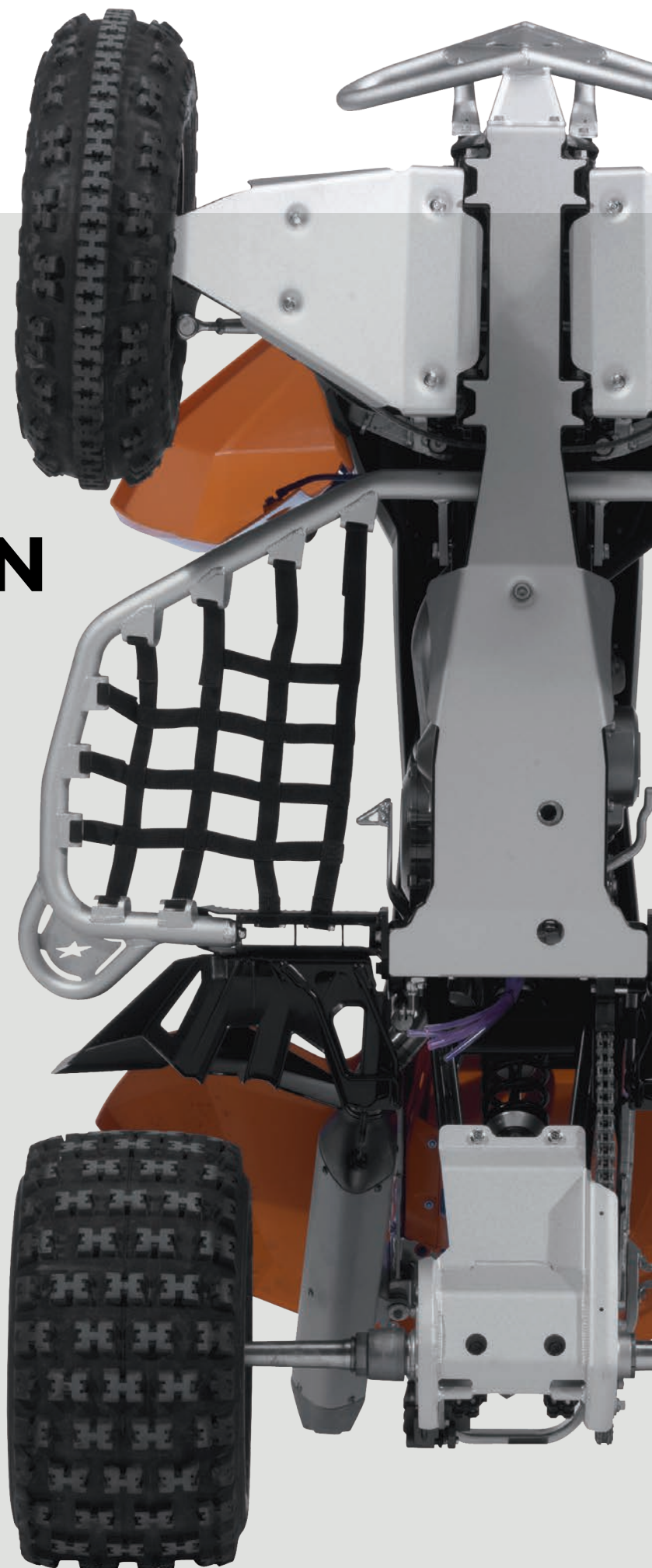



## DTC TRIANGLE COVERS

- 2CP045\_ (Front)
- 2CPT16\_ (Rear)

# DTC

## PROTECTION PARTS

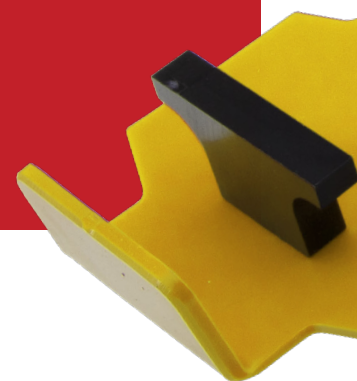

- » Replace the (\*\*\*\*) for the code of the desired color Example: Red Color 2CP0450001**0500**
- » Substituir os (\*\*\*\*) pelo código de cor pretendida.Exemplo: para a cor vermelha 2CP0450001**0500**

 »0300	 »0400	 »0500	 »0600	 »0700	 »0900
Black Preto	Blue Azul	Red Vermelho	White Branco	Yellow Amarelo	Orange Laranja







## **DTC CARTER COVERS**

- 2CP058\_ (6mm)
- 2CP096\_ (8mm)

*Available in 6 or 8mm*  
*Disponível em 6 ou 8mm*













- » Conceito Inovador
- » Fabricado em DTC de Alta Densidade de 6mm e 8mm.
- » Não vibra e não provoca ruído
- » Não dobra ou quebra
- » Mais resistente ao risco que o alumínio
- » Metade do peso do alumínio
- » Testado intensivamente por pilotos TOP

- » Innovative concept
- » Manufactured of a high density 6mm and 8mm DTC
- » Does not rattle or vibrate
- » Do not bend or break
- » More scratch resistant than aluminum
- » Half the weight of aluminum
- » Intensely tested by top ATV pilots

# ALUMINUM PROTECTION PARTS

» Replace the (\*\*\*\*) for the code of the desired color Example: Red Color 2CP0050001**0007**

» Substituir os (\*\*\*\*) pelo código de cor pretendida:Exemplo: para a cor vermelha 2CP0050001**0007**

 »0001	 »0002	 »0004	 »0005	 »0006	 »0007	 »0008	 »0009	 »0010	 »0011
Ice Matte Ice Polish	Polish Polido	Black Preto	Textured Black Preto Texturado	White Branco	Red Vermelho	Yellow Amarelo	Green Verde	Orange Laranja	Blue Azul

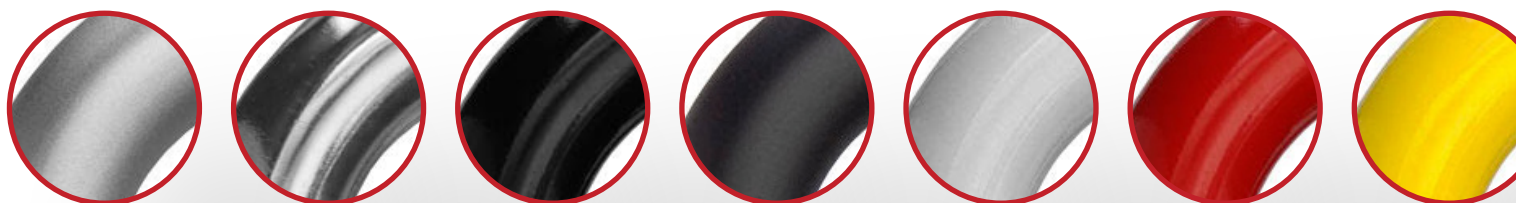

# CARTER COVERS

• 2CP040\_



# TRIANGLE COVER

- 2CP038\_ (Front)
- 2CP039\_ (Rear)





**STEEL**

**DISC GUARD**

•2CP140\_

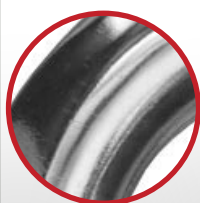
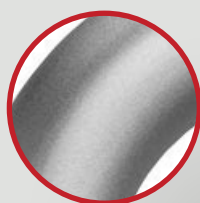

# ALUMINUM

## DISC GUARD













### DISC GUARD ALUMINUM

•2CP04L

» Replace the (\*\*\*\*) for the code of the desired color Example: Red Color 2CP0010001**0007**

» Substituir os (\*\*\*\*) pelo código de cor pretendida.Exemplo: para a cor vermelha 2CP0010001**0007**

 »0001	 »0002	 »0004	 »0005	 »0006	 »0007	 »0008	 »0009	 »0010	 »0011
Ice Matte Ice Polish	Polish Polido	Black Preto	Textured Black Preto Texturado	White Branco	Red Vermelho	Yellow Amarelo	Green Verde	Orange Laranja	Blue Azul





# CHAIN PROTECTION

•2CP099\_

## QUAD ACCESSÓRIES



### CHAIN PROTECTION

•2CP042\_

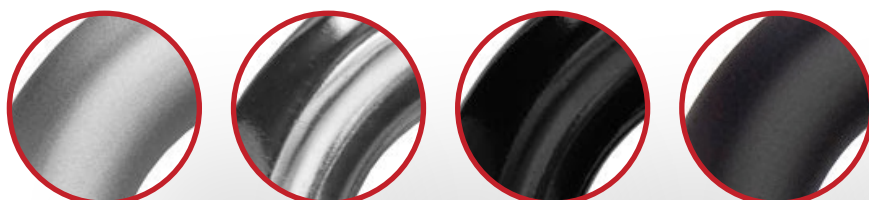











# FRAME GUARDS



» Replace the (\*\*\*\*) for the code of the desired color Example: Red Color 2CP0010001**0007**

» Substituir os (\*\*\*\*) pelo código de cor pretendida.Exemplo: para a cor vermelha 2CP0010001**0007**

 »0001	 »0002	 »0004	 »0005	 »0006	 »0007	 »0008	 »0009	 »0010	 »0011
Ice Matte Ice Polish	Polish Polido	Black Preto	Textured Black Preto Texturado	White Branco	Red Vermelho	Yellow Amarelo	Green Verde	Orange Laranja	Blue Azul



## SHOCK ABSORBER PROTECTION



• 2CP04400020001

SUZUKI LT-Z 400  
ARCTIC CAT DVX 400  
KAWASAKI KFX 400

## ENGINE CONTROL PROTECTION



• 2CP1030001\_











SUZUKI LT-R 450



# FRONT RADIATOR PROTECTION



- » Replace the (\*\*\*\*) for the code of the desired color Example: Red Color 2CP0010001**0007**
- » Substituir os (\*\*\*\*) pelo código de cor pretendida:Exemplo: para a cor vermelha 2CP0010001**0007**

 »0001	 »0002	 »0004	 »0005	 »0006	 »0007	 »0008	 »0009	 »0010	 »0011
Ice Matte Ice Polish	Polish Polido	Black Preto	Textured Black Preto Texturado	White Branco	Red Vermelho	Yellow Amarelo	Green Verde	Orange Laranja	Blue Azul

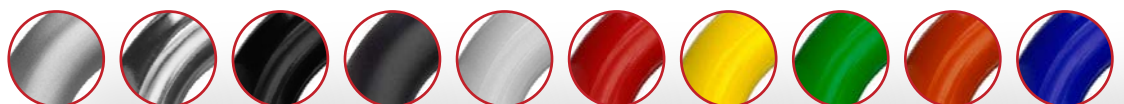

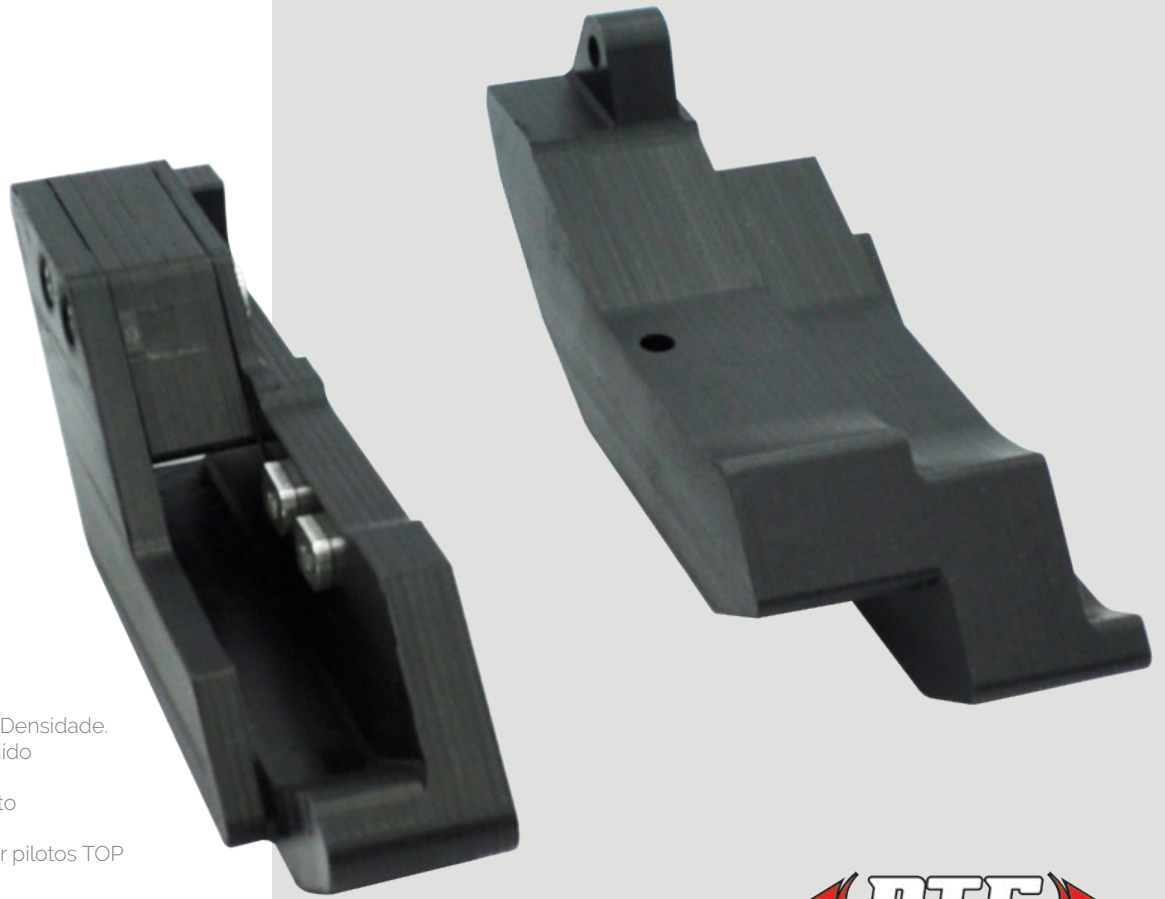

- »Conceito Inovador
- »Fabricado em DTC de Alta Densidade.
- »Não vibra e não provoca ruído
- »Sem soldas
- »Maior resistência ao impacto
- »100% maquinada
- »Testado intensivamente por pilotos TOP

- »Innovative concept
- »Manufactured of a high density DTC
- »Does not rattle or vibrate
- »No Welds
- »Impact Resistance
- »100% Machined
- »Intensely tested by top ATV pilots



# DTC DISC GUARD

• 2CP120001A0300 SUZUKI LT-R 450 (all)



*\*Pinhão não incluído*

\*Front sprocket not included



# DTC CASE SAVER

• 2CP12800230300

YAMAHA YFZ350 Banshee



»De forma assegurar a máxima protecção da sua moto, a Crosspro oferece uma gama de capas de amortecedores.

»Estas protecções protegem não só contra o pó e lama mas também contra pedras e outros objectos.

»In order to ensure maximum protection of your motorcycle, CROSSPRO offers a range of dampers covers.

»These protections not only protect against dust and mud, but also against stones and other objects.

# SHOCK COVERS

• 2CP075\_



• 2CP049\_

## REAR HOLD RACING

- complete with number plate

»A Pega Traseira "Racing", foi desenvolvida para uma utilização em competição, o seu porta número, permite ao piloto colocar o seu número ou identificação, não interferindo com a sua condução e segurança.

»Permitindo uma completa personalização, disponível em diferentes cores e acabamentos.

»TheRearHold "Racing", was developed for a utilization in competition, the number hold allows to the pilot to put is number or identification, without it interferes on is driving or safety.

»Allows a complete personalization, available in different colors and finishing's.

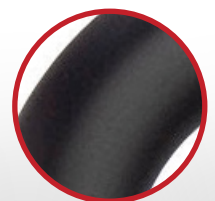
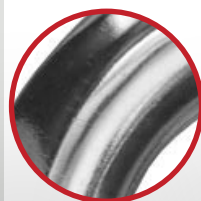
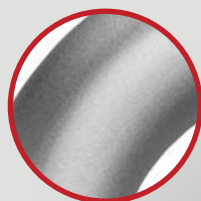

# ALUMINUM REAR HOLDS



## STANDARD REAR HOLD • 2CP048\_

»As pegas traseiras, além da sua função habitual, pode ainda ser utilizada para suporte de luzes, porta matrículas e porta números.











»A CrossPro oferece dois modelos de pegas traseiras Tipo Origem e Racing, este último mais completo, disponíveis em vários acabamentos permite uma personalização da sua moto adequada às suas preferências.

»The rear handle bars, in addition to its usual function, can also be used to support lights, plates and numbers.

»CROSSPRO offers two models, Origin and Racing, the Racing is more complete, available in various finishing's, allows the customization of your motorcycle suited to your preferences.

» Replace the (\*\*\*\*) for the code of the desired color Example: Red Color 2CP0480001**0007**

» Substituir os (\*\*\*\*) pelo código de cor pretendida:Exemplo: para a cor vermelha 2CP0480001**0007**

 »0001	 »0002	 »0004	 »0005	 »0006	 »0007	 »0008	 »0009	 »0010	 »0011
Ice Matte Ice Polish	Polish Polido	Black Preto	Textured Black Preto Texturado	White Branco	Red Vermelho	Yellow Amarelo	Green Verde	Orange Laranja	Blue Azul





Hugo Moreira Audiovisuais

# NUMBER PLATE



• 2CP0950000\_



• 2CP0950001\_



• 2CP0950048\_



• 2CP0950055\_

- » Replace the ( ) for the code of the desired color Example: Red Color 2CP0950001**0500**
- » Substituir os ( ) pelo código de cor pretendida:Exemplo: para a cor vermelha 2CP0950001**0500**

● »0300	● »0400	● »0500	○ »0600	● »0700	● »0900
Black Preto	Blue Azul	Red Vermelho	White Branco	Yellow Amarelo	Orange Laranja

# REAR HOLD STICKERS

•2CP142\_



# WHEEL SPACERS

•2CP052\_

»Os Alargadores são utilizados para atribuir maior estabilidade à sua moto 4, aumentando a sua segurança, permitindo uma melhor condução e desempenho.

»Cada Kit é composto por 2 alargadores e 8 pernos

»Utilizando apenas 8 modelos de alargadores e conjugando com diferentes pernos, é possível configurar o seu alargador para todos os modelos de motos, conseguindo de forma simples ajustar e personalizar o alargador às suas necessidades.

»Esta inovação permite:

- Redução de custos e espaço de stock
- Maior comodidade para si e seus clientes

»Disponível também em vários acabamentos

»The Wheel Spacers are used to help in the stability of your moto 4, increasing your safety and allowing a better driving and performance.

»Each Kit contains 2 Wheel Spacers and 8 bolts.

»Using only 8 models of Wheel Spacers with different bolts, is possible to configure your Wheel Spacer to all moto 4 models, accomplishing in a simple way adjust and personalize the Wheel Spacer to your needs.

»This innovation allows:

- Reduce the costs and space in stock
- More convenience for you and your clients

»Available in different colors.



*Available in  
45, 65 and 100mm  
thickness*

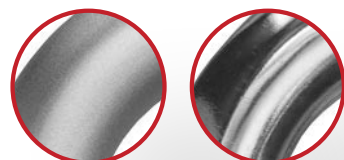



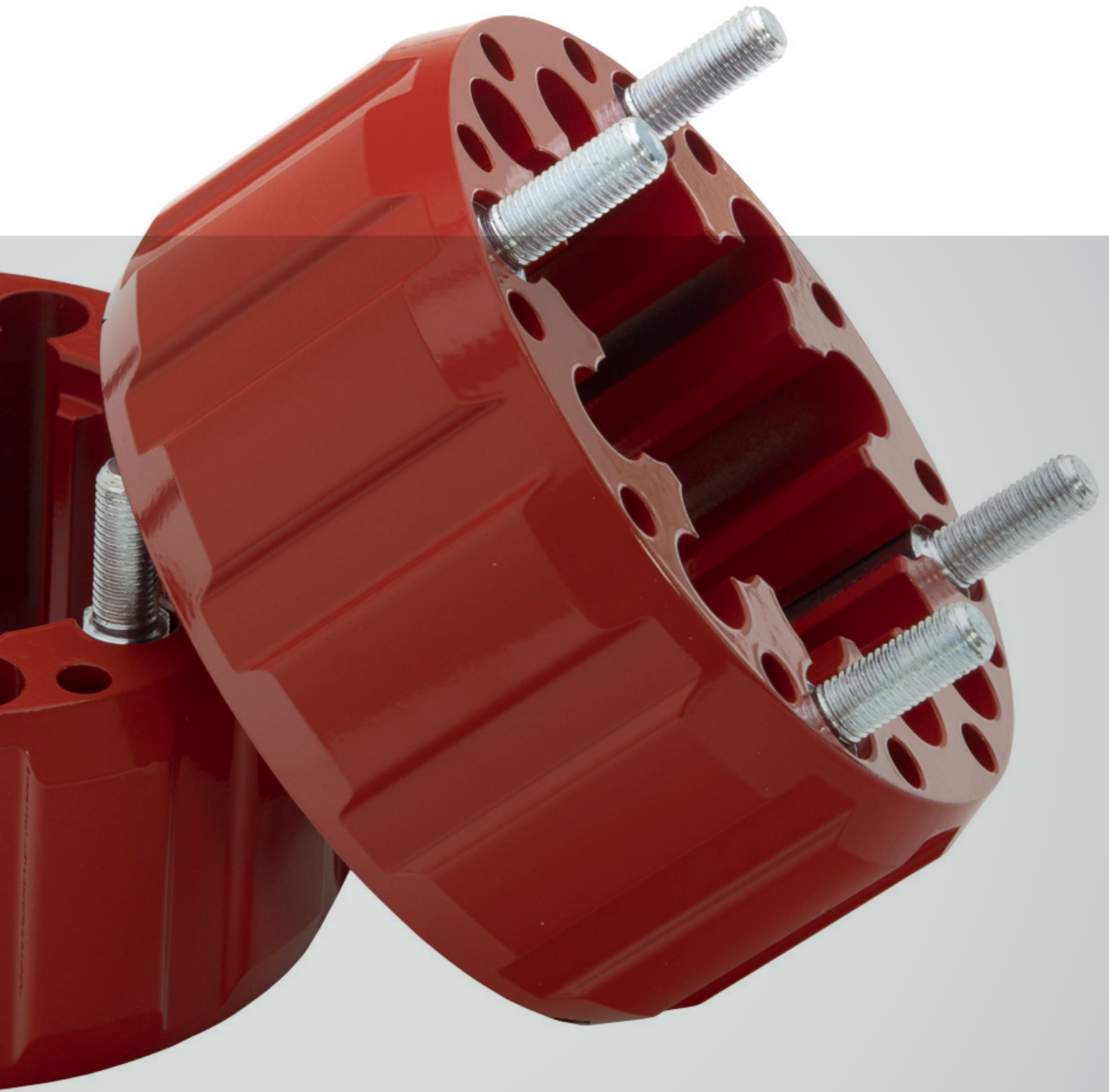

• PERFLA



• PERFIL C

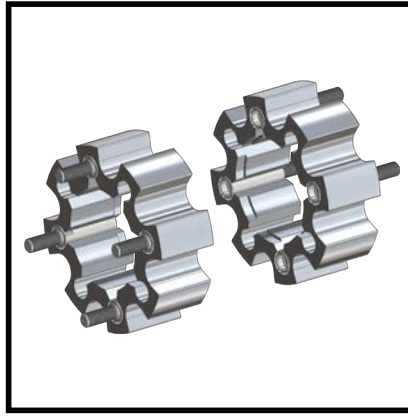

• PERFIL D



• PERFIL G



• PERFIL I



• PERFIL J

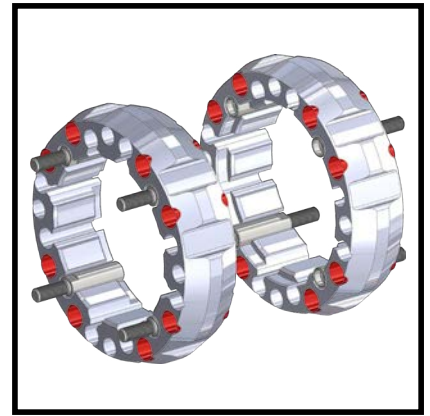

DISTANCE BETWEEN BOLTS	THREADED BOLTS	MODEL NAME	45MM	65MM	100MM
100	3/8"-24	A-16	2CP0520029	2CP0520072	2CP0520098
100	3/8"-24	C-16	2CP0520056	2CP0520082	2CP0520107
100	3/8"-24	I-16	2CP0520063	2CP0520089	2CP0520114
100	M10x1,25	A-15	2CP0520028	2CP0520036	2CP0520037
100	M10x1,25	C-15	2CP0520043	2CP0520076	2CP0520101
100	M10x1,25	I-15	2CP0520062	2CP0520088	2CP0520113
100	M10x1,50	A-17	2CP0520030	2CP0520073	2CP0520099
100	M10x1,50	C-17	2CP0520057	2CP0520083	2CP0520108
100	M10x1,50	I-17	2CP0520064	2CP0520090	2CP0520115
101,5	1/2"-20	C-21	2CP0520034	2CP0520074	2CP0520049
101,5	M12x1,25	C-32	2CP0520059	2CP0520085	2CP0520110
101,5	M12x1,50	C-22	2CP0520058	2CP0520084	2CP0520109
110	1/2"-20	I-21	2CP0520065	2CP0520091	2CP0520116
110	3/8"-24	A-16	2CP0520029	2CP0520072	2CP0520098
110	M10x1,25	A-15	2CP0520028	2CP0520036	2CP0520037
110	M10x1,50	A-17	2CP0520030	2CP0520073	2CP0520099
110	M12x1,25	I-32	2CP0520066	2CP0520092	2CP0520117
110	M12x1,50	I-22	2CP0520051	2CP0520078	2CP0520103
115	3/8"-24	A-16	2CP0520029	2CP0520072	2CP0520098
115	3/8"-24	I-16	2CP0520063	2CP0520089	2CP0520114
115	M10x1,25	A-15	2CP0520028	2CP0520036	2CP0520037
115	M10x1,25	I-15	2CP0520062	2CP0520088	2CP0520113
115	M10x1,50	A-17	2CP0520030	2CP0520073	2CP0520099
115	M10x1,50	I-17	2CP0520064	2CP0520090	2CP0520115
136,5	1/2"-20	J-21	2CP0520070	2CP0520096	2CP0520121
136,5	3/8"-24	D-16	2CP0520053	2CP0520079	2CP0520104
136,5	3/8"-24	G-16	2CP0520048	2CP0520077	2CP0520102
136,5	M10x1,25	D-15	2CP0520042	2CP0520075	2CP0520100

DISTANCE BETWEEN BOLTS	THREADED BOLTS	MODEL NAME	45MM	65MM	100MM
136,5	M10x1,25	G-15	2CP0520060	2CP0520086	2CP0520111
136,5	M10x1,50	D-17	2CP0520054	2CP0520080	2CP0520105
136,5	M10x1,50	G-17	2CP0520061	2CP0520087	2CP0520112
136,5	M12x1,25	J-32	2CP0520071	2CP0520097	2CP0520122
136,5	M12x1,50	J-22	2CP0520055	2CP0520081	2CP0520106
144	3/8"-24	D-16	2CP0520053	2CP0520079	2CP0520104
144	3/8"-24	G-16	2CP0520048	2CP0520077	2CP0520102
144	3/8"-24	J-16	2CP0520068	2CP0520094	2CP0520119
144	M10x1,25	D-15	2CP0520042	2CP0520075	2CP0520100
144	M10x1,25	G-15	2CP0520060	2CP0520086	2CP0520111
144	M10x1,25	J-15	2CP0520067	2CP0520093	2CP0520118
144	M10x1,50	D-17	2CP0520054	2CP0520080	2CP0520105
144	M10x1,50	G-17	2CP0520061	2CP0520087	2CP0520112
144	M10x1,50	J-17	2CP0520069	2CP0520095	2CP0520120
156	1/2"-20	J-21	2CP0520070	2CP0520096	2CP0520121
156	3/8"-24	D-16	2CP0520053	2CP0520079	2CP0520104
156	3/8"-24	G-16	2CP0520048	2CP0520077	2CP0520102
156	3/8"-24	J-16	2CP0520068	2CP0520094	2CP0520119
156	M10x1,25	D-15	2CP0520042	2CP0520075	2CP0520100
156	M10x1,25	G-15	2CP0520060	2CP0520086	2CP0520111
156	M10x1,25	J-15	2CP0520067	2CP0520093	2CP0520118
156	M10x1,50	D-17	2CP0520054	2CP0520080	2CP0520105
156	M10x1,50	G-17	2CP0520061	2CP0520087	2CP0520112
156	M10x1,50	J-17	2CP0520069	2CP0520095	2CP0520120
156	M12x1,25	J-32	2CP0520071	2CP0520097	2CP0520122
156	M12x1,50	J-22	2CP0520055	2CP0520081	2CP0520106
156,4	1/2"-20	J-21	2CP0520070	2CP0520096	2CP0520121
156,4	M12x1,25	J-32	2CP0520071	2CP0520097	2CP0520122
156,4	M12x1,50	J-22	2CP0520055	2CP0520081	2CP0520106





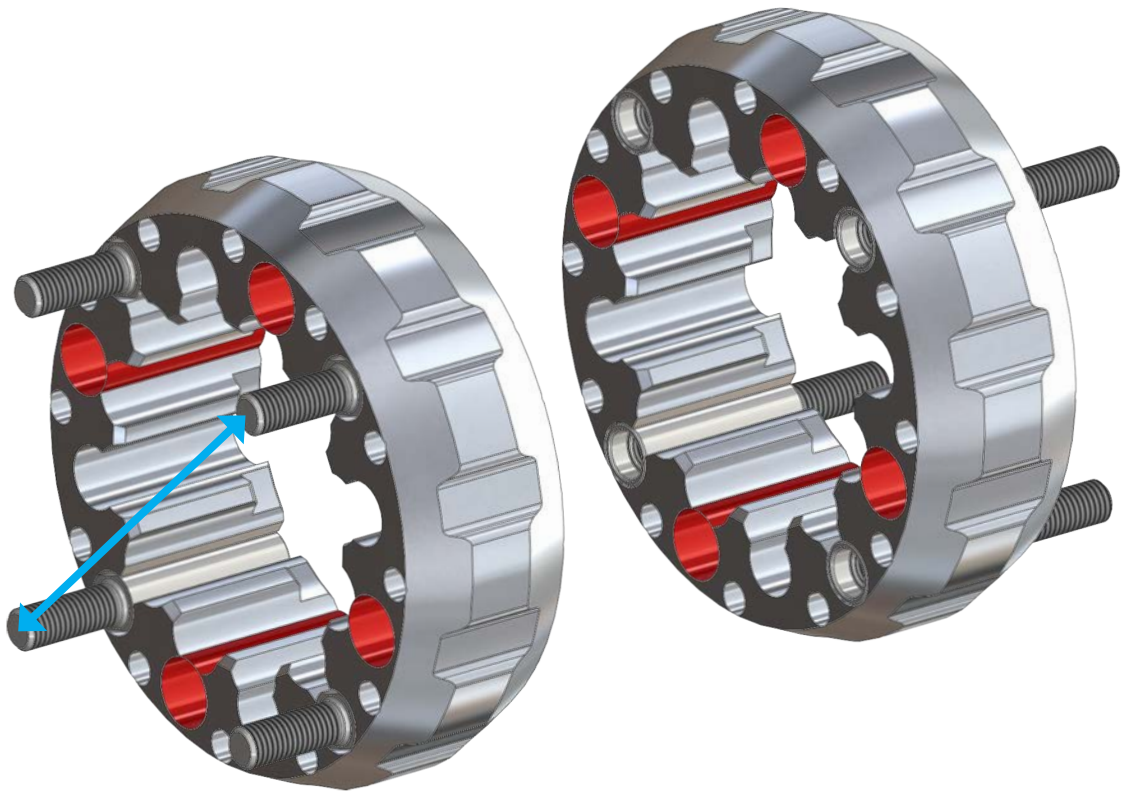





# WHEEL SPACERS

•2CP052\_



» Replace the (\*\*\*\*) for the code of the desired color Example: Red Color 2CP05200010007

» Substituir os (\*\*\*\*) pelo código de cor pretendida: Exemplo: para a cor vermelha 2CP05200010007

 »0001	 »0002	 »0004	 »0005	 »0006	 »0007	 »0008	 »0009	 »0010	 »0011
Ice Matte Ice Polish	Polish Polido	Black Preto	Textured Black Preto Texturado	White Branco	Red Vermelho	Yellow Amarelo	Green Verde	Orange Laranja	Blue Azul

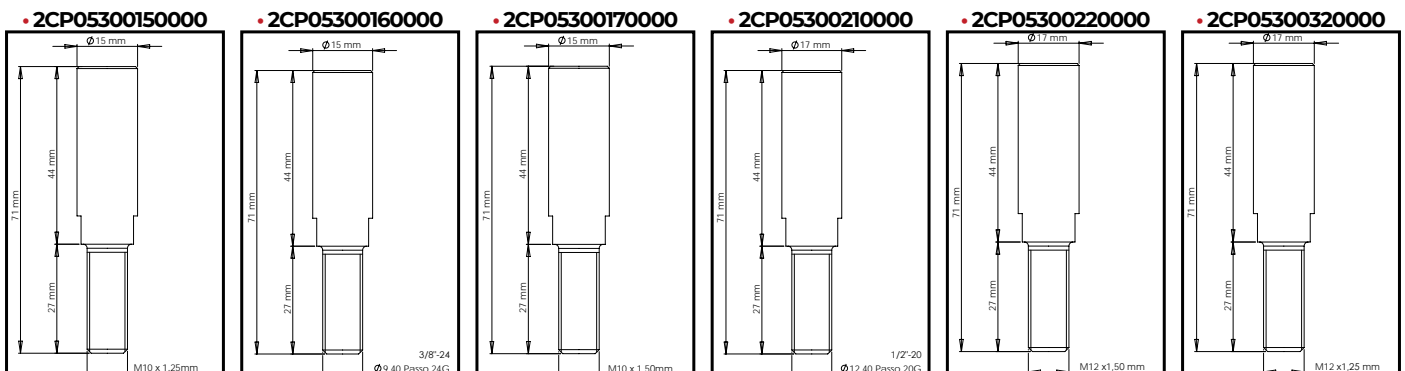

# utility ATVs hard protections

## » Protege o mais importante com Crosspro

Além das protecções para o seu ATV e UTV, a CrossPro aposta em produtos que permitem maximizar a sua segurança.

Conjugando um vasto conhecimento sobre estes equipamentos e os melhores materiais, a CrossPro oferece uma gama completa de protecções e acessórios que lhe permitirão usufruir da melhor forma da sua moto.

Desenvolvida e construída por profissionais qualificados, esta é a protecção adequada a um cliente ciente da importância da protecção da sua moto.

## » Protect the important with CrossPro

Besides the ATV and UTV protections, CrossPro bets on products that allow maximizing your safety.

Combining the knowledge of these equipments with the best materials, CrossPro offers a complete range of protections and accessories that will allow you to enjoy your moto.

Developed and built by skilled professionals, this is adequate protection to a customer who knows the importance of protecting his bike.



# ALUMINUM PROTECTION ATV

»A Crosspro apresenta a gama mais completa do mercado de protecções para ATVs e UTVs.

»Produzidos com Alumínio de 5mm de espessura , as protecções Crosspro protegem cada cm do seu ATV/UTV.

»Todas as protecções encaixam perfeitamente umas nas outras, por forma a proporcionar a maior estabilidade, protecção e resistência.

»Crosspro presents the most complete range of protections parts for your ATVs and UTVs.

»Produced with 5mm thickness, Crosspro Protection parts protect every cm of your ATV/UTV.

»All ATV parts interlocks with each other in order to give maximum stability, strength and protection

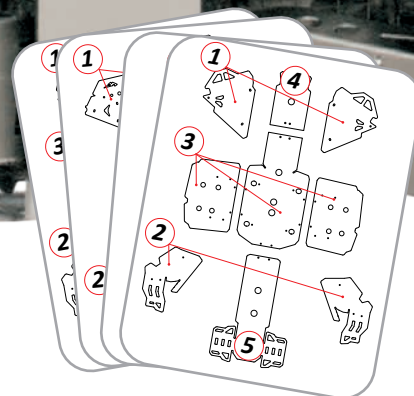



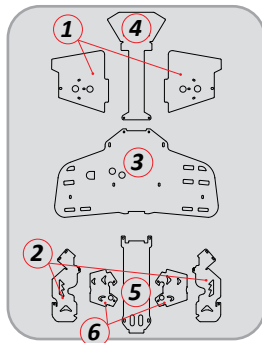

**2CP055035A000\***

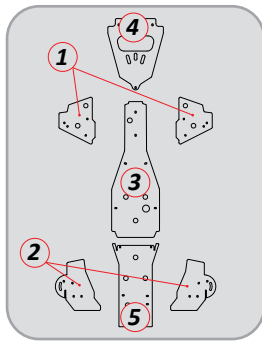

**2CP0550036000\***

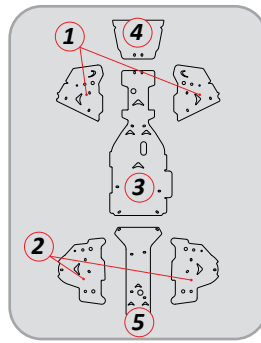

**2CP0550037000\***

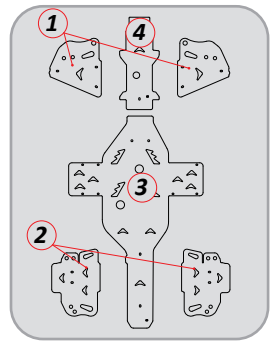

**2CP0550038000\***

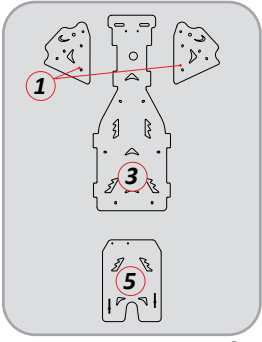

**2CP0550039000\***

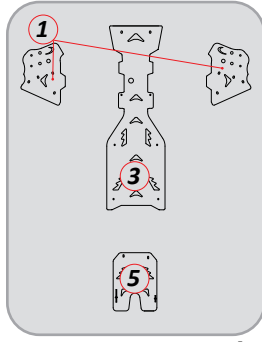

**2CP0550040000\***

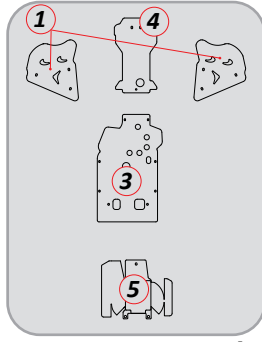

**2CP0550041000\***

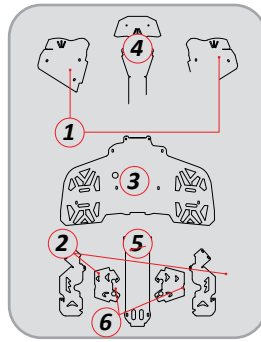

**2CP055042A000\***

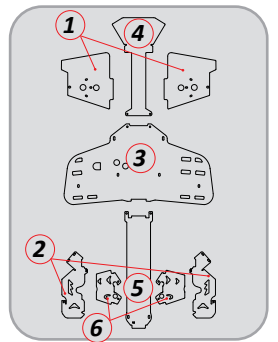

**2CP055043A000\***

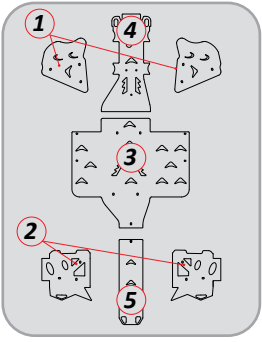

**2CP0550046000\***

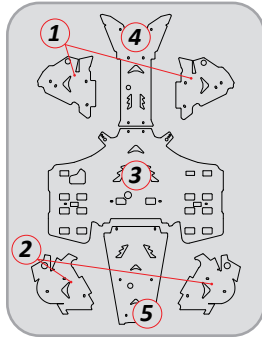

**2CP0550047000\***

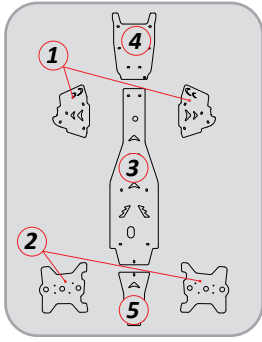

**2CP0550050000\***

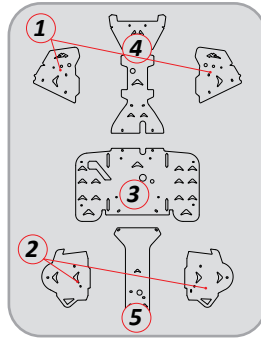

**2CP0550052000\***

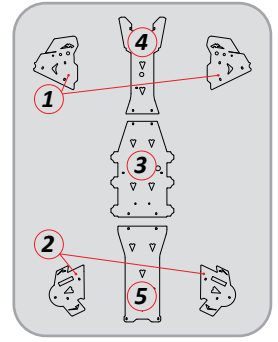

**2CP0550053000\***

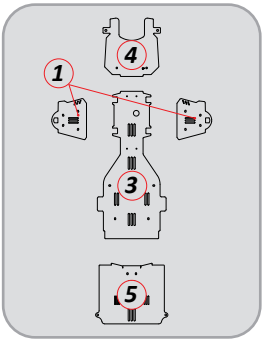

**2CP0550056000\***

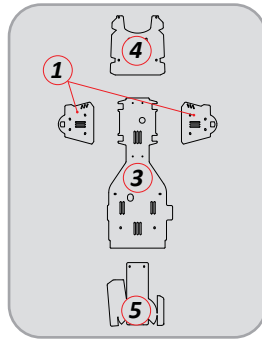

**2CP0550057000\***

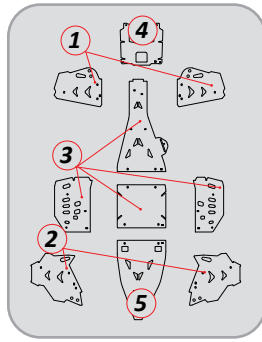

**2CP0550060000\***

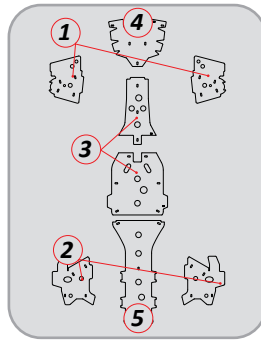

**2CP0550062000\***

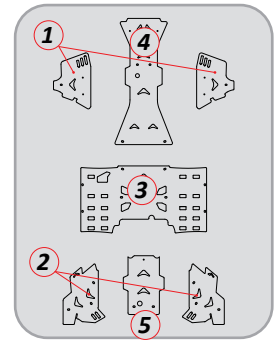

**2CP0550072000\***

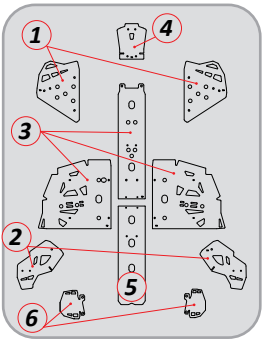

**2CP0550079000\***

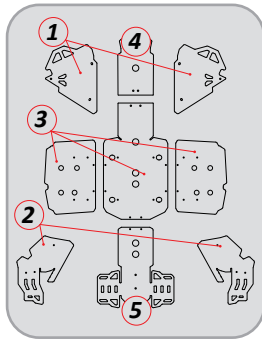

**2CP0550085000\***

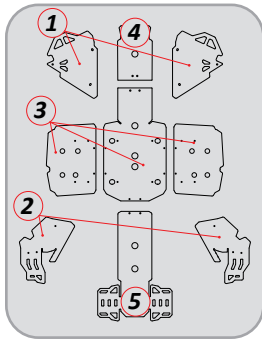

**2CP0550086000\***

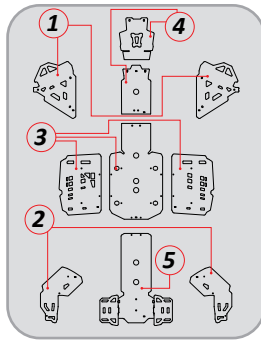

**2CP0550093000\***



# DTC PROTECTION ATV



CAN-AM	COLOR	COMPLET KIT	(1)FRONT A-ARMS	(2)REAR A-ARMS	(3)CENTRAL CARTER	(4)FRONT CARTER	(5)REAR CARTER	(6)CARDAN
500/650/800 Outlander (2006-2012)	● Black	2CP13900350300	2CP04500350300	-	2CP14300350300	2CP14400350300	2CP14500350300	-
	● Blue	-	2CP04500350400	-	-	-	-	-
	● Red	-	2CP04500350500	-	-	-	-	-
	○ White	-	2CP04500350600	-	-	-	-	-
	● Yellow	-	2CP04500350700	-	-	-	-	-
500/650/800 Outlander MAX (2006-2012)	● Orange	-	2CP04500350900	-	-	-	-	-
	● Black	2CP13900430300	2CP04500430300	-	2CP14300430300	2CP14400430300	2CP14500430300	-
	● Blue	-	2CP04500430400	-	-	-	-	-
	● Red	-	2CP04500430500	-	-	-	-	-
	○ White	-	2CP04500430600	-	-	-	-	-
1000 Outlander Maxx (2013-2015)	● Yellow	-	2CP04500430700	-	-	-	-	-
	● Orange	-	2CP04500430900	-	-	-	-	-
	● Black	2CP13900860300	2CP04500860300	2CP11600860300	2CP14300860300	2CP14400420300	2CP14500420300	-
	● Blue	-	2CP04500860400	2CP11600860400	-	-	-	-
	● Red	-	2CP04500860500	2CP11600860500	-	-	-	-
1000 Outlander X MR (2013-2015)	○ White	-	2CP04500860600	2CP11600860600	-	-	-	-
	● Yellow	-	2CP04500860700	2CP11600860700	-	-	-	-
	● Orange	-	2CP04500860900	2CP11600860900	-	-	-	-
	● Black	2CP13900850300	2CP04500850300	2CP11600850300	2CP14300850300	2CP14400850300	2CP14500850300	-
	● Blue	-	2CP04500850400	2CP11600850400	-	-	-	-
1000 Renegade (2012-2015)	● Red	-	2CP04500850500	2CP11600850500	-	-	-	-
	○ White	-	2CP04500850600	2CP11600850600	-	-	-	-
	● Yellow	-	2CP04500850700	2CP11600850700	-	-	-	-
	● Orange	-	2CP04500850900	2CP11600850900	-	-	-	-
	● Black	2CP13900790300	2CP04500790300	2CP11600790300	2CP14300790300	2CP14400790300	2CP14500790300	2CP14600790300
1000 Renegade (2012-2015)	● Blue	-	2CP04500790400	2CP11600790400	-	-	-	2CP14600790400
	● Red	-	2CP04500790500	2CP11600790500	-	-	-	2CP14600790500
	○ White	-	2CP04500790600	2CP11600790600	-	-	-	2CP14600790600
	● Yellow	-	2CP04500790700	2CP11600790700	-	-	-	2CP14600790700
	● Orange	-	2CP04500790900	2CP11600790900	-	-	-	2CP14600790900

»A Crosspro apresenta a gama mais completa do mercado de protecções para ATVs e UTVs.

»Produzidos em DTC de 8mm de espessura, as protecções Crosspro protegem cada cm do seu ATV/ UTV.

»Todas as protecções encaixam perfeitamente umas nas outras, por forma a proporcionar a maior estabilidade, protecção e resistência.

»Crosspro presents the most complete range of protection parts for your ATVs and UTVs.

»Produced with DTC 8mm thickness, Crosspro Protection parts protect every cm of your ATV/UTV.

»All ATV parts interlock with each other in order to give maximum stability, strength and protection

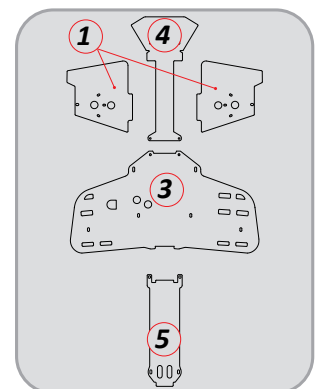

**2CP13900350\*\*\***

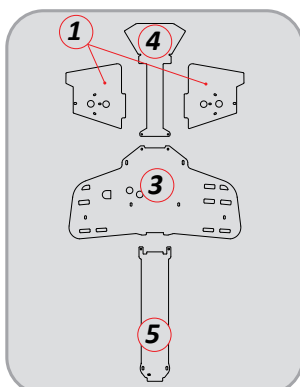

**2CP13900430\*\*\***

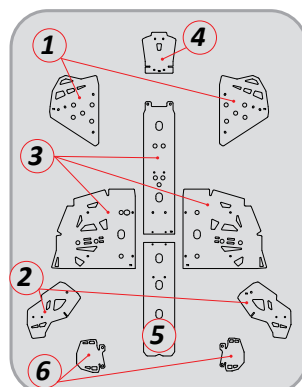

**2CP13900790\*\*\***

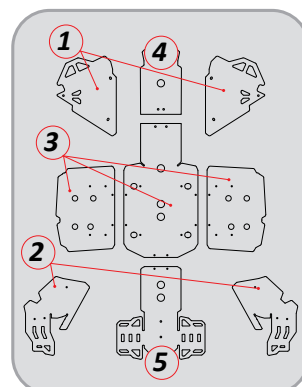

**2CP13900850\*\*\***

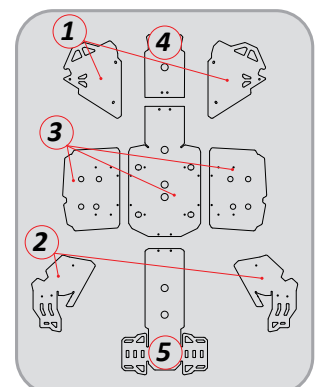

**2CP13900860\*\*\***



»Os Pára-choques da CrossPro para ATV's / UTV's combinam resistência com design  
 »Produzidos em alumínio T6061, com tubo de 35mm  
 »A melhor escolha

»The Bumper of CrossPro ATV's / UTV's strength combined with design  
 »Produced in T6061 aluminum with 35mm tubing  
 »The best choice

# ATV BUMPERS

		● ICE MATTE	● BLACK	● TEXTURED BLACK
<b>GOES</b> 520 Max (all years)	FRONT	2CP06200530001	2CP06200530004	2CP06200530005
	REAR	2CP0630530001	2CP0630530004	2CP0630530005
<b>HONDA</b> 680 Rincon (2008-2014)	FRONT	2CP06200500001	2CP06200500004	2CP06200500005
	REAR	2CP06300500001	2CP06300500004	2CP06300500005
<b>KAWASAKI</b> 750 KVF 4x4 (2008-2011)	FRONT	2CP06200520001	2CP06200520004	2CP06200520005
	REAR	2CP06300520001	2CP06300520004	2CP06300520005
<b>KYMCO</b> 500 MXU (2009-2010)	FRONT	2CP06200390001	2CP06200390004	2CP06200390005
	REAR	2CP06300390001	2CP06300390004	2CP06300390005
<b>POLARIS</b> 700/800 Sportsman TWIN	FRONT	2CP06200380001	2CP06200380004	2CP06200380005
	REAR	2CP06300380001	2CP06300380004	2CP06300380005
<b>TGB</b> 425 Blade (2008)	FRONT	2CP06200570001	2CP06200570004	2CP06200570005
	REAR	2CP06300570001	2CP06300570004	2CP06300570005
<b>SUZUKI</b> 450 King Quad (2007-2010)	FRONT	2CP06200490001	2CP06200490004	2CP06200490005
	REAR	2CP06300490001	2CP06300490004	2CP06300490005
	FRONT	2CP06200490001	2CP06200490004	2CP06200490005
	REAR	2CP06300490001	2CP06300490004	2CP06300490005
700 King Quad (2006-2007)	FRONT	2CP06200490001	2CP06200490004	2CP06200490005
	REAR	2CP06300490001	2CP06300490004	2CP06300490005
750 King Quad	FRONT	2CP06200490001	2CP06200490004	2CP06200490005
	REAR	2CP06300490001	2CP06300490004	2CP06300490005
<b>YAMAHA</b> 700 Grizzly (2007-2013)	FRONT	2CP06200470001	2CP06200470004	2CP06200470005
	REAR	2CP06300470001	2CP06300470004	2CP06300470005







**YAMAHA**  
RACING  
SUPPORTED TEAM

**» Protege o mais importante com Crosspro**

Além das protecções para o seu ATV e UTV, a CrossPro aposta em produtos que permitem maximizar a sua segurança.

Conjugando um vasto conhecimento sobre estes equipamentos e os melhores materiais, a CrossPro oferece uma gama completa de protecções e acessórios que lhe permitirão usufruir da melhor forma da sua moto.

Desenvolvida e construída por profissionais qualificados, esta é a protecção adequada a um cliente ciente da importância da protecção da sua moto.

**» Protect the important with CrossPro**

Besides the ATV and UTV protections, CrossPro bets on products that allow maximizing your safety.

Combining the knowledge of these equipments with the best materials, CrossPro offers a complete range of protections and accessories that will allow you to enjoy your moto.

Developed and built by skilled professionals, this is adequate protection to a customer who knows the importance of protecting his bike.



side  
by side

# YAMAHA

## YXZ 1000R/SE

### 2016



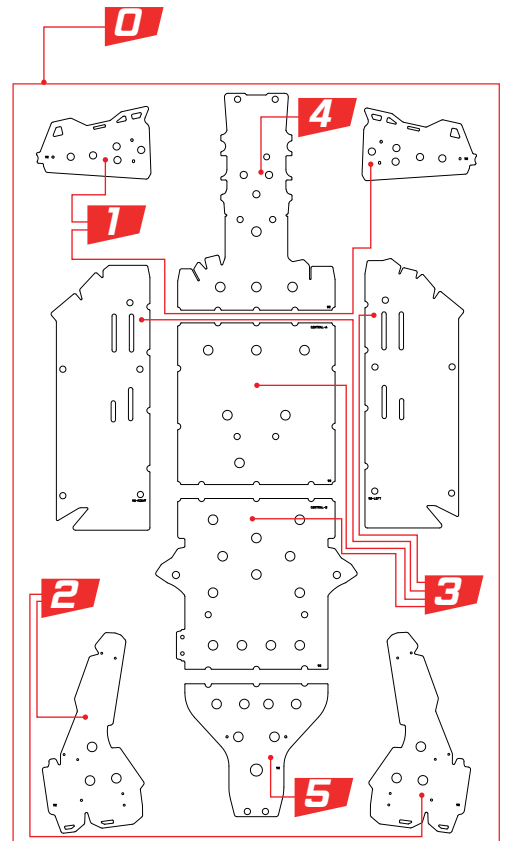

**DTC 8mm**  
**YXZ 1000 R 2016**

● BLACK

<b>0</b>	<b>Complet Kit</b> Kit Completo	2CP18700920300
<b>1</b>	<b>Front A-arms</b> Triângulos da frente	2CP18800920300
<b>2</b>	<b>Rear A-arms</b> Triângulos de trás	2CP18900920300
<b>3</b>	<b>Central Carter</b> Carter Central	2CP19000920300
<b>4</b>	<b>Front Carter</b> Carter Frente	2CP19100920300
<b>5</b>	<b>Rear Carter</b> Carter trás	2CP19200920300

**POLYCARBONATE**  
**YXZ 1000 R/RSS**

● TRANSP.

<b>12</b>	<b>Air deflector</b> Defletor de ar 2016-2018	2CP18500920100
<b>12</b>	<b>Air deflector</b> Defletor de ar 2019-2020	2CP1850A920100

**ALUMINUM**  
**YXZ 1000 R 2016**

● ICE MATTE

● NEUTRAL

● BLACK

● TEXT. BLACK

○ WHITE

<b>0</b>	<b>Complet Kit</b> Kit Completo	2CP05600920001	2CP05600920003	2CP05600920004	2CP05600920005	2CP05600920006
<b>1</b>	<b>Front A-arms</b> Triângulos da frente	2CP03800920001	2CP03800920003	2CP03800920004	2CP03800920005	2CP03800920006
<b>2</b>	<b>Rear A-arms</b> Triângulos de trás	2CP03900920001	2CP03900920003	2CP03900920004	2CP03900920005	2CP03900920006
<b>3</b>	<b>Central Carter</b> Carter Central	2CP06600920001	2CP06600920003	2CP06600920004	2CP06600920005	2CP06600920006
<b>4</b>	<b>Front Carter</b> Carter Frente	2CP06400920001	2CP06400920003	2CP06400920004	2CP06400920005	2CP06400920006
<b>5</b>	<b>Rear Carter</b> Carter Traseiro	2CP06500920001	2CP06500920003	2CP06500920004	2CP06500920005	2CP06500920006
<b>6</b>	<b>Front Bumper</b> Pára-choques Frontal	2CP06200920001	-	2CP06200920004	2CP06200920005	2CP06200920006
<b>7</b>	<b>Front Bumper</b> Pára-choques Frontal	2CP0620A920001	-	2CP0620A920004	2CP0620A920005	2CP0620A920006
<b>8</b>	<b>Rear Bumper</b> Pára-choques trás	2CP06300920001	-	2CP06300920004	2CP06300920005	2CP06300920006
<b>9</b>	<b>Bottom side bar</b> Embaladeiras	2CP05700920001	-	2CP05700920004	2CP05700920005	2CP05700920006



# ARCTIC CAT

## WILDCAT 1000

### 2012-2015

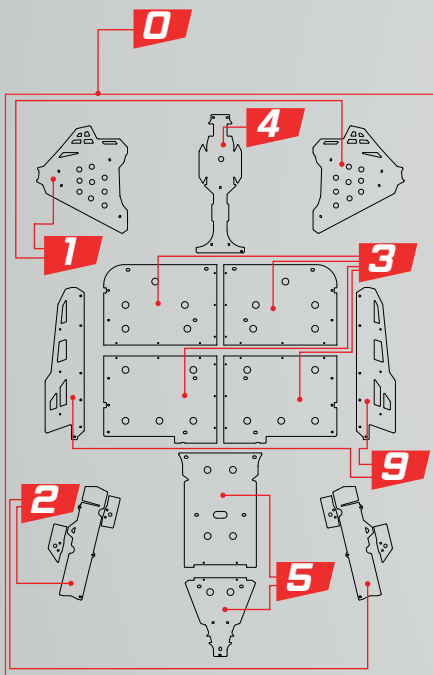

**DORS  
WILDCAT 1000**

**6** FRAME ICE MATTE

● BLACK

● BLUE

● RED

○ WHITE

● YELLOW

● ORANGE

2CP14800810301

2CP14800810401

2CP14800810501

2CP14800810601

2CP14800810701

2CP14800810801



**DORS  
WILDCAT 1000**

**6** ● FRAME BLACK

● BLACK

● BLUE

● RED

○ WHITE

● YELLOW

● ORANGE

2CP14800810305

2CP14800810405

2CP14800810505

2CP14800810605

2CP14800810705

2CP14800810805





### ALUMINUM WILDCAT 1000

	● ICE MATTE	● NEUTRAL	● BLACK	● TEXT. BLACK	○ WHITE
<b>0</b> <b>Complet Kit</b> Kit Completo	2CP05600 <b>81</b> 0001	2CP05600 <b>81</b> 0003	2CP05600 <b>81</b> 0004	2CP05600 <b>81</b> 0005	2CP05600 <b>81</b> 0006
<b>1</b> <b>Front A-arms</b> Triângulos da frente	2CP03800 <b>81</b> 0001	2CP03800 <b>81</b> 0003	2CP03800 <b>81</b> 0004	2CP03800 <b>81</b> 0005	2CP03800 <b>81</b> 0006
<b>2</b> <b>Rear A-arms</b> Triângulos de trás	2CP03900 <b>81</b> 0001	2CP03900 <b>81</b> 0003	2CP03900 <b>81</b> 0004	2CP03900 <b>81</b> 0005	2CP03900 <b>81</b> 0006
<b>3</b> <b>Central Carter</b> Carter Central	2CP06600 <b>81</b> 0001	2CP06600 <b>81</b> 0003	2CP06600 <b>81</b> 0004	2CP06600 <b>81</b> 0005	2CP06600 <b>81</b> 0006
<b>4</b> <b>Front Carter</b> Carter Frente	2CP06400 <b>81</b> 0001	2CP06400 <b>81</b> 0003	2CP06400 <b>81</b> 0004	2CP06400 <b>81</b> 0005	2CP06400 <b>81</b> 0006
<b>5</b> <b>Rear Carter</b> Carter Traseiro	2CP06500 <b>81</b> 0001	2CP06500 <b>81</b> 0003	2CP06500 <b>81</b> 0004	2CP06500 <b>81</b> 0005	2CP06500 <b>81</b> 0006
<b>6</b> <b>Side Doors</b> Portas Laterais	2CP05000 <b>81</b> 0001	-	2CP05000 <b>81</b> 0004	2CP05000 <b>81</b> 0005	2CP05000 <b>81</b> 0006
<b>7</b> <b>Front Bumper</b> Para-choques Frontal	2CP06200 <b>81</b> 0001	-	2CP06200 <b>81</b> 0004	2CP06200 <b>81</b> 0005	2CP06200 <b>81</b> 0006
<b>8</b> <b>Rear Bumper</b> Para-choques trás	2CP06300 <b>81</b> 0001	-	2CP06300 <b>81</b> 0004	2CP06300 <b>81</b> 0005	2CP06300 <b>81</b> 0006
<b>9</b> <b>Bottom side bar</b> Embaladeiras	2CP05700 <b>81</b> 0001	-	2CP05700 <b>81</b> 0004	2CP05700 <b>81</b> 0005	2CP05700 <b>81</b> 0006
<b>10</b> <b>Rear extenders</b> Alargadores de trás	2CP05200 <b>28</b> 0001	-	2CP05200 <b>28</b> 0004	2CP05200 <b>28</b> 0005	2CP05200 <b>28</b> 0006
<b>11</b> <b>Front extenders</b> Alargadores da frente	2CP05200 <b>28</b> 0001	-	2CP05200 <b>28</b> 0004	2CP05200 <b>28</b> 0005	2CP05200 <b>28</b> 0006

### DTC WILDCAT 1000

	● BLACK	● BLUE	● RED	○ WHITE	● YELLOW	● ORANGE
<b>1</b> <b>Front A-arms</b> Triângulos da frente	2CP04500 <b>81</b> 0300	2CP04500 <b>81</b> 0400	2CP04500 <b>81</b> 0500	2CP04500 <b>81</b> 0600	2CP04500 <b>81</b> 0700	2CP04500 <b>81</b> 0900
<b>3</b> <b>Central Carter</b> Carter Central	2CP14300 <b>81</b> 0300	2CP14300 <b>81</b> 0400	2CP14300 <b>81</b> 0500	2CP14300 <b>81</b> 0600	2CP14300 <b>81</b> 0700	2CP14300 <b>81</b> 0900
<b>4</b> <b>Front Carter</b> Carter Frente	2CP14400 <b>81</b> 0300	2CP14400 <b>81</b> 0400	2CP14400 <b>81</b> 0500	2CP14400 <b>81</b> 0600	2CP14400 <b>81</b> 0700	2CP14400 <b>81</b> 0900
<b>5</b> <b>Rear Carter</b> Carter Traseiro	2CP14500 <b>81</b> 0300	2CP14500 <b>81</b> 0400	2CP14500 <b>81</b> 0500	2CP14500 <b>81</b> 0600	2CP14500 <b>81</b> 0700	2CP14500 <b>81</b> 0900

# CAN-AM

## COMMANDER

### XT 800/1000

### 2012-2015



ALUMINUM XT 800/1000 12-15		● ICE MATTE	● NEUTRAL	● BLACK	● TEXT. BLACK	○ WHITE
<b>0</b> Complet Kit Kit Completo	2CP05600630001	2CP05600630003	2CP05600630004	2CP05600630005	2CP05600630006	
<b>1</b> Front A-arms Triângulos da frente	2CP03800630001	2CP03800630003	2CP03800630004	2CP03800630005	2CP03800630006	
<b>2</b> Central Carter Carter Central	2CP06600630001	2CP06600630003	2CP06600630004	2CP06600630005	2CP06600630006	
<b>3</b> Front Carter Carter Frente	2CP06400630001	2CP06400630003	2CP06400630004	2CP06400630005	2CP06400630006	
<b>4</b> Rear Carter Carter Central	2CP06500630001	2CP06500630003	2CP06500630004	2CP06500630005	2CP06500630006	
<b>5</b> Side Doors Portas Laterais	2CP05000630001	-	2CP05000630004	2CP05000630005	2CP05000630006	
<b>6</b> Front Bumper Pára-choques Frontal	2CP06200630001	-	2CP06200630004	2CP06200630005	2CP06200630006	
<b>7</b> Bottom side bar Embaladeiras	2CP05700630001	-	2CP05700630004	2CP05700630005	2CP05700630006	
<b>8</b> Rear extenders Alargadores de trás	2CP05200420001	-	2CP05200420004	2CP05200420005	2CP05200420006	
<b>9</b> Front extenders Alargadores da frente	2CP05200420001	-	2CP05200420004	2CP05200420005	2CP05200420006	

DTC XT 800/1000 12-15		● BLACK	● BLUE	● RED	○ WHITE	● YELLOW	● ORANGE
<b>0</b> Complet Kit Kit Completo	2CP14700630300	2CP14700630400	2CP14700630500	2CP14700630600	2CP14700630700	2CP14700630900	
<b>1</b> Front A-arms Triângulos da frente	2CP04500630300	2CP04500630400	2CP04500630500	2CP04500630600	2CP04500630700	2CP04500630900	
<b>2</b> Central Carter Carter Central	2CP14300630300	2CP14300630400	2CP14300630500	2CP14300630600	2CP14300630700	2CP14300630900	
<b>3</b> Front Carter Carter Frente	2CP14400630300	2CP14400630400	2CP14400630500	2CP14400630600	2CP14400630700	2CP14400630900	
<b>4</b> Rear Carter Carter Trás	2CP14500630300	2CP14500630400	2CP14500630500	2CP14500630600	2CP14500630700	2CP14500630900	



**6**

**9**

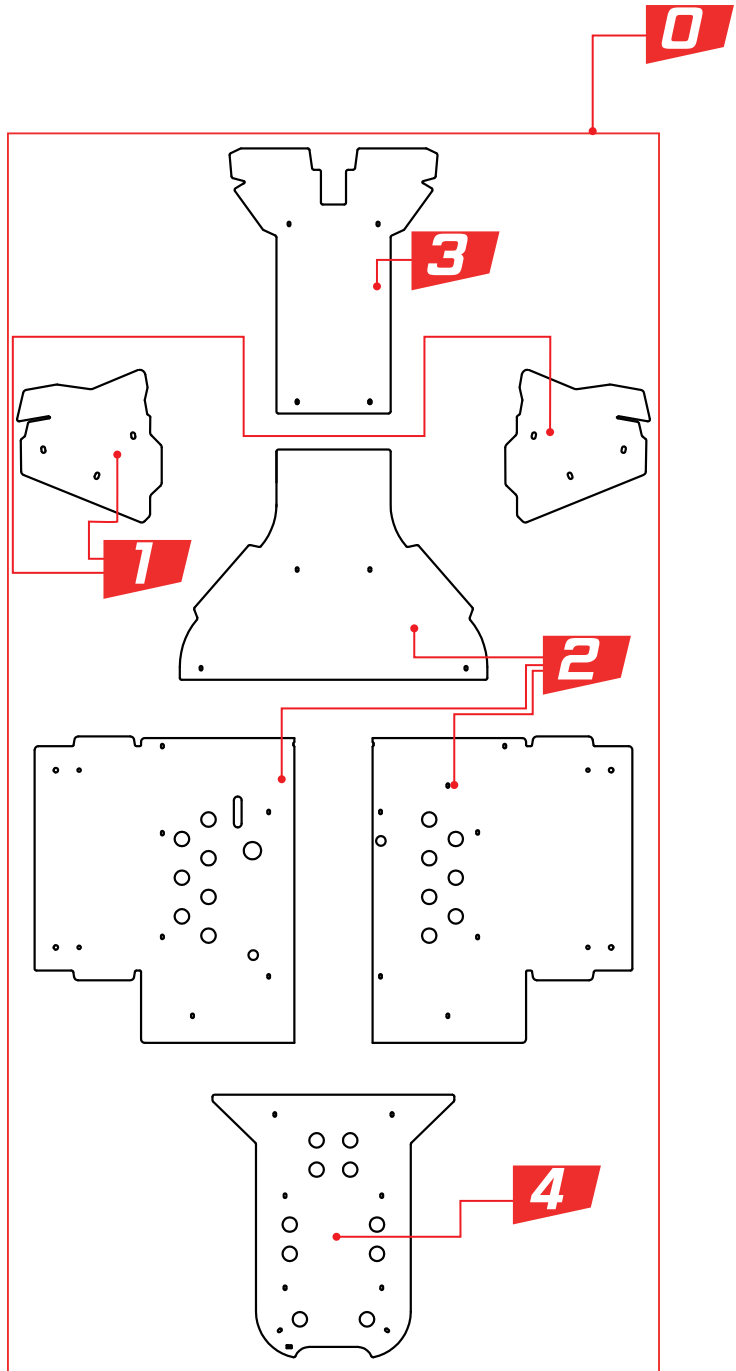

**DORS**  
**XT 800/1000 12-15**

**6** ● FRAME ICE MATTE



● BLACK    ● BLUE    ● RED    ○ WHITE    ● YELLOW    ● ORANGE  
2CP14800630301    2CP14800630401    2CP14800630501    2CP14800630601    2CP14800630701    2CP14800630801



**DORS**  
**XT 800/1000 12-15**

**6** ● FRAME BLACK



● BLACK    ● BLUE    ● RED    ○ WHITE    ● YELLOW    ● ORANGE  
2CP14800630305    2CP14800630405    2CP14800630505    2CP14800630605    2CP14800630705    2CP14800630805

# CAN-AM

## MAVERICK 1000

### 2013



**DORS**  
**MAVERICK 1000**

**6** FRAME ICE MATTE

- BLACK  
2CP14800880301
- BLUE  
2CP14800880401
- RED  
2CP14800880501
- WHITE  
2CP14800880601
- YELLOW  
2CP14800880701
- ORANGE  
2CP14800880801



**DORS**  
**MAVERICK 1000**

**6** ● FRAME BLACK

- BLACK  
2CP14800880305
- BLUE  
2CP14800880405
- RED  
2CP14800880505
- WHITE  
2CP14800880605
- YELLOW  
2CP14800880705
- ORANGE  
2CP14800880805

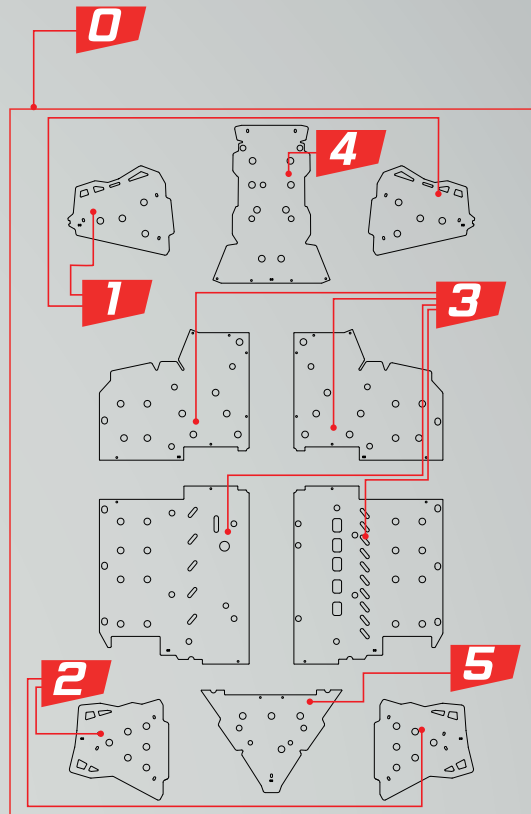

**ALUMINUM  
MAVERICK 1000**

● ICE MATTE ● NEUTRAL ● BLACK ● TEXT. BLACK ○ WHITE

<b>0</b> Complet Kit Kit Completo	2CP05600880001	2CP05600880003	2CP05600880004	2CP05600880005	2CP05600880006
<b>1</b> Front A-arms Triângulos da frente	2CP03800880001	2CP03800880003	2CP03800880004	2CP03800880005	2CP03800880006
<b>2</b> Rear A-arms Triângulos de trás	2CP03900880001	2CP03900880003	2CP03900880004	2CP03900880005	2CP03900880006
<b>3</b> Central Carter Carter Central	2CP06600880001	2CP06600880003	2CP06600880004	2CP06600880005	2CP06600880006
<b>4</b> Front Carter Carter Frente	2CP06400880001	2CP06400880003	2CP06400880004	2CP06400880005	2CP06400880006
<b>5</b> Rear Carter Carter Traseiro	2CP06500880001	2CP06500880003	2CP06500880004	2CP06500880005	2CP06500880006
<b>6</b> Side Doors Portas Laterais	2CP05000880001	-	2CP05000880004	2CP05000880005	2CP05000880006
<b>7</b> Front Bumper Pára-choques Frontal	2CP06200880001	-	2CP06200880004	2CP06200880005	2CP06200880006
<b>8</b> Rear Bumper Pára-choques trás	2CP06300880001	-	2CP06300880004	2CP06300880005	2CP06300880006
<b>9</b> Bottom side bar Embaladeiras	2CP05700880001	2CP05700880003	2CP05700880004	2CP05700880005	2CP05700880006
<b>10</b> Rear extenders Alargadores de trás	2CP05200420001	-	2CP05200420004	2CP05200420005	2CP05200420006
<b>11</b> Front extenders Alargadores da frente	2CP05200420001	-	2CP05200420004	2CP05200420005	2CP05200420006
<b>12</b> Roof Tejadilho	-	-	2CP17500880004	2CP17500880005	2CP17500880006

**DTC  
MAVERICK 1000**

● BLACK ● BLUE ● RED ○ WHITE ● YELLOW ● ORANGE

<b>0</b> Complet Kit Kit Completo	2CP14700880300	2CP14700880400	2CP14700880500	2CP14700880600	2CP14700880700	2CP14700880900
<b>1</b> Front A-arms Triângulos da frente	2CP04500880300	2CP04500880400	2CP04500880500	2CP04500880600	2CP04500880700	2CP04500880900
<b>2</b> Rear A-arms Triângulos da trás	2CP11600880300	2CP11600880400	2CP11600880500	2CP11600880600	2CP11600880700	2CP11600880900
<b>3</b> Central Carter Carter Central	2CP14300880300	2CP14300880400	2CP14300880500	2CP14300880600	2CP14300880700	2CP14300880900
<b>4</b> Front Carter Carter Frente	2CP14400880300	2CP14400880400	2CP14400880500	2CP14400880600	2CP14400880700	2CP14400880900
<b>5</b> Rear Carter Carter Traseiro	2CP14500880300	2CP14500880400	2CP14500880500	2CP14500880600	2CP14500880700	2CP14500880900
<b>T</b> Roof 8mm Tejadilho 8mm	2CP17400880300	-	-	-	-	-

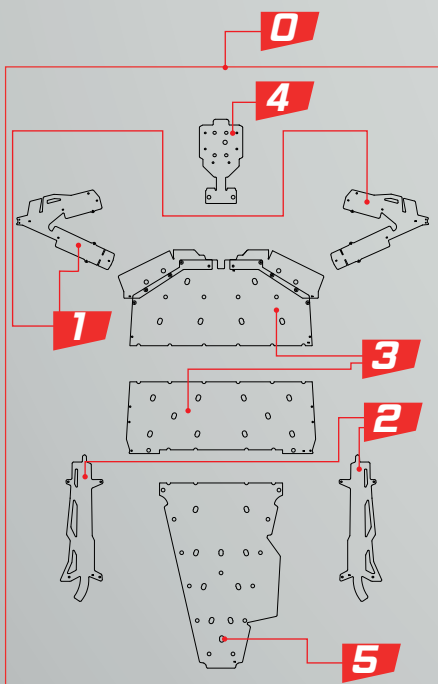

DTC MAVERICK X3		● BLACK
<b>2</b>	Rear A-arms (6mm) Triângulos de trás *not for XD S	2CP11600940300
<b>3</b>	Central Carter (8mm) Carter Central	2CP19000940300
<b>4</b>	Front Carter (6mm) Carter Frente	2CP14400940300
<b>5</b>	Rear Carter (8mm) Carter trás	2CP19200940300

ALUMINUM MAVERICK X3		● ICE MATTE	● NEUTRAL	● BLACK	● TEXT. BLACK	○ WHITE
<b>0</b>	Complet Kit *not for XD S Kit Completo	2CP05600940001	2CP05600940003	2CP05600940004	2CP05600940005	2CP05600940006
<b>1</b>	Front A-arms Triângulos da frente *not for XD S	2CP03800940001	2CP03800940003	2CP03800940004	2CP03800940005	2CP03800940006
<b>2</b>	Rear A-arms Triângulos de trás *not for XD S	2CP03900940001	2CP03900940003	2CP03900940004	2CP03900940005	2CP03900940006
<b>3</b>	Central Carter Carter Central	2CP06600940001	2CP06600940003	2CP06600940004	2CP06600940005	2CP06600940006
<b>4</b>	Front Carter Carter Frente	2CP06400940001	2CP06400940003	2CP06400940004	2CP06400940005	2CP06400940006
<b>5</b>	Rear Carter Carter Traseiro	2CP06500940001	2CP06500940003	2CP06500940004	2CP06500940005	2CP06500940006
<b>6</b>	Side Doors Portas Laterais	2CP05000940001	-	2CP05000940004	2CP05000940005	2CP05000940006
<b>*6</b>	Cover for original Doors Capa p/ Portas (originais)	2CP0500A940001	-	2CP050A940004	2CP050A940005	2CP050A940006
<b>7</b>	Front Bumper Pára-choques Frontal	2CP062094A0001	-	2CP062094A0004	2CP062094A0005	2CP062094A0006
<b>9</b>	Bottom side bar Embaladeiras	2CP05700940001	-	2CP05700940004	2CP05700940005	2CP05700940006
<b>10</b>	Rear extenders Alargadores de trás	2CP05200500001	-	2CP05200500004	2CP05200500005	2CP05200500006
<b>11</b>	Front extenders Alargadores da frente	2CP05200500001	-	2CP05200500004	2CP05200500005	2CP05200500006

# CAN-AM

## MAVERICK X3

TURBO/X DS\* / X RC/X RS

# 2017-2019



**7**

**7**

**11**

### // TRAILER HITCH

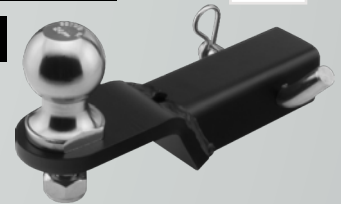

Trailer Hitch (Support only)	2CP19400010004
Trailer Ball (Ball only)	RP23400100



#### DORS MAVERICK X3

<b>6</b> FRAME ICE MATTE	● BLACK	● BLUE	● RED	○ WHITE	● YELLOW	● ORANGE
	2CP14800940301	2CP14800940401	2CP14800940501	2CP14800940601	2CP14800940701	2CP14800940801



#### DORS MAVERICK X3

<b>6</b> ● FRAME BLACK	● BLACK	● BLUE	● RED	○ WHITE	● YELLOW	● ORANGE
	2CP14800940305	2CP14800940405	2CP14800940505	2CP14800940605	2CP14800940705	2CP14800940805

# POLARIS

## RZR

### 800/800s



#### ALUMINUM RZR 800 08-14

● ICE MATTE ● NEUTRAL ● BLACK ● TEXT. BLACK ○ WHITE

<b>0</b> Complet Kit Kit Completo	2CP05600450001	2CP05600450003	2CP05600450004	2CP05600450005	2CP05600450006
<b>1</b> Front A-arms Triângulos da frente	2CP03800450001	2CP03800450003	2CP03800450004	2CP03800450005	2CP03800450006
<b>2</b> Rear A-arms Triângulos de trás	2CP03900450001	2CP03900450003	2CP03900450004	2CP03900450005	2CP03900450006
<b>3</b> Central Carter Carter Central	2CP06600450001	2CP06600450003	2CP06600450004	2CP06600450005	2CP06600450006
<b>4</b> Front Carter Carter Frente	2CP06400450001	2CP06400450003	2CP06400450004	2CP06400450005	2CP06400450006
<b>5</b> Rear Carter Carter Traseiro	2CP06500450001	2CP06500450003	2CP06500450004	2CP06500450005	2CP06500450006
<b>6</b> Side Doors Portas Laterais	2CP05000450001	-	2CP05000450004	2CP05000450005	2CP05000450006
<b>7</b> Front Bumper Pára-choques Frontal	2CP06200450001	-	2CP06200450004	2CP06200450005	2CP06200450006
<b>8</b> Rear Bumper Pára-choques trás	2CP06300450001	-	2CP06300450004	2CP06300450005	2CP06300450006
<b>9</b> Bottom side bar Embaladeiras	2CP05700450001	-	2CP05700450004	2CP05700450005	2CP05700450006
<b>10</b> Rear extenders Alargadores de trás	2CP05200320001	-	2CP05200320004	2CP05200320005	2CP05200320006
<b>11</b> Front extenders Alargadores da frente	2CP05200320001	-	2CP05200320004	2CP05200320005	2CP05200320006

#### ALUMINUM RZR 800s 09-14

● ICE MATTE ● NEUTRAL ● BLACK ● TEXT. BLACK ○ WHITE

<b>0</b> Complet Kit Kit Completo	2CP05600660001	2CP05600660003	2CP05600660004	2CP05600660005	2CP05600660006
<b>1</b> Front A-arms Triângulos da frente	2CP03800660001	2CP03800660003	2CP03800660004	2CP03800660005	2CP03800660006
<b>2</b> Rear A-arms Triângulos de trás	2CP03900660001	2CP03900660003	2CP03900660004	2CP03900660005	2CP03900660006
<b>3</b> Central Carter Carter Central	2CP06600450001	2CP06600450003	2CP06600450004	2CP06600450005	2CP06600450006
<b>4</b> Front Carter Carter Frente	2CP06400450001	2CP06400450003	2CP06400450004	2CP06400450005	2CP06400450006
<b>5</b> Rear Carter Carter Traseiro	2CP06500660001	2CP06500660003	2CP06500660004	2CP06500660005	2CP06500660006
<b>6</b> Side Doors Portas Laterais	2CP05000450001	-	2CP05000450004	2CP05000450005	2CP05000450006
<b>7</b> Front Bumper Pára-choques Frontal	2CP06200450001	-	2CP06200450004	2CP06200450005	2CP06200450006
<b>8</b> Rear Bumper Pára-choques trás	2CP06300450001	-	2CP06300450004	2CP06300450005	2CP06300450006
<b>9</b> Bottom side bar Embaladeiras	2CP05700660001	-	2CP05700660004	2CP05700660005	2CP05700660006
<b>10</b> Rear extenders Alargadores de trás	2CP05200320001	-	2CP05200320004	2CP05200320005	2CP05200320006
<b>11</b> Front extenders Alargadores da frente	2CP05200320001	-	2CP05200320004	2CP05200320005	2CP05200320006

#### RZR 800

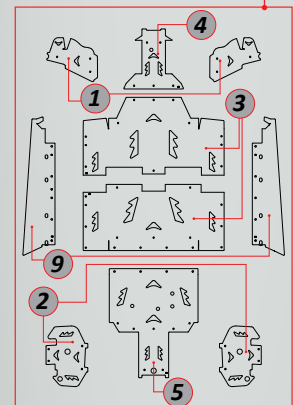

#### RZR 800s

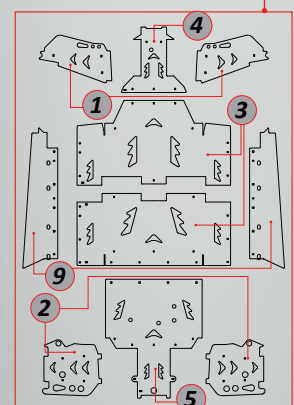





DORS RZR 800 08-14	● BLACK	● BLUE	● RED	○ WHITE	● YELLOW	● ORANGE
<b>6</b> ● FRAME ICE MATTE	2CP14800450301	2CP14800450401	2CP14800450501	2CP14800450601	2CP14800450701	2CP14800450801
DORS RZR 800s 09-14	● BLACK	● BLUE	● RED	○ WHITE	● YELLOW	● ORANGE
<b>6</b> ● FRAME ICE MATTE	2CP14800450301	2CP14800450401	2CP14800450501	2CP14800450601	2CP14800450701	2CP14800450801



DORS RZR 800 08-14	● BLACK	● BLUE	● RED	○ WHITE	● YELLOW	● ORANGE
<b>6</b> ● FRAME BLACK	2CP14800450305	2CP14800450405	2CP14800450505	2CP14800450605	2CP14800450705	2CP14800450805
DORS RZR 800s 09-14	● BLACK	● BLUE	● RED	○ WHITE	● YELLOW	● ORANGE
<b>6</b> ● FRAME BLACK	2CP14800450305	2CP14800450405	2CP14800450505	2CP14800450605	2CP14800450705	2CP14800450805



### » RZR 800

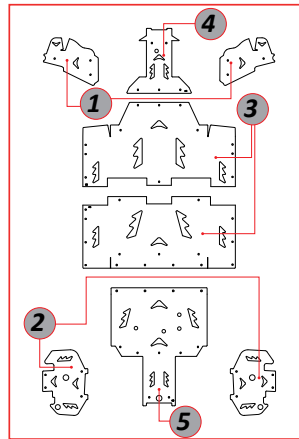

### » RZR 800S

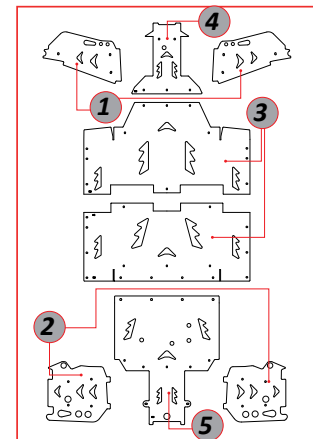

DTC RZR 800 08-14	● BLACK	● BLUE	● RED	○ WHITE	● YELLOW	● ORANGE
<b>1</b> Front A-arms Triângulos da frente	2CP04500450300	2CP04500450400	2CP04500450500	2CP04500450600	2CP04500450700	2CP04500450900
<b>2</b> Rear A-arms Triângulos de trás	2CP11600450300	2CP11600450400	2CP11600450500	2CP11600450600	2CP11600450700	2CP11600450900
<b>3</b> Central Carter Carter Central	2CP14300450300	2CP14300450400	2CP14300450500	2CP14300450600	2CP14300450700	2CP14300450900
<b>4</b> Front Carter Carter Frente	2CP14400450300	2CP14400450400	2CP14400450500	2CP14400450600	2CP14400450700	2CP14400450900
<b>5</b> Rear Carter Carter Traseiro	2CP14500450300	2CP14500450400	2CP14500450500	2CP14500450600	2CP14500450700	2CP14500450900

DTC RZR 800s 09-14	● BLACK	● BLUE	● RED	○ WHITE	● YELLOW	● ORANGE
<b>1</b> Front A-arms Triângulos da frente	2CP04500660300	2CP04500660400	2CP04500660500	2CP04500660600	2CP04500660700	2CP04500660900
<b>2</b> Rear A-arms Triângulos de trás	2CP11600660300	2CP11600660400	2CP11600660500	2CP11600660600	2CP11600660700	2CP11600660900
<b>3</b> Central Carter Carter Central	2CP14300450300	2CP14300450400	2CP14300450500	2CP14300450600	2CP14300450700	2CP14300450900
<b>4</b> Front Carter Carter Frente	2CP14400450300	2CP14400450400	2CP14400450500	2CP14400450600	2CP14400450700	2CP14400450900
<b>5</b> Rear Carter Carter Traseiro	2CP14500660300	2CP14500660400	2CP14500660500	2CP14500660600	2CP14500660700	2CP14500660900

# POLARIS

## RZR 900

### 2011-2014



**DORS**  
RZR 900 11-14

**6** • FRAME ICE MATTE



**DORS**  
RZR 900 11-14

**5** • FRAME BLACK





**7**

**11**

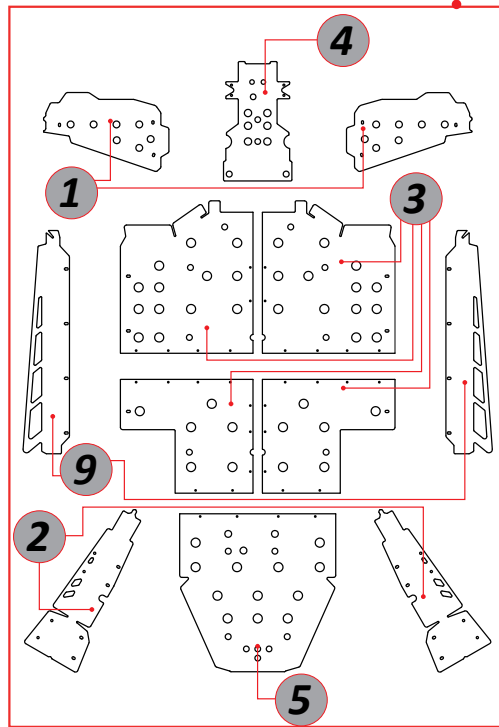

**ALUMINUM  
RZR 900 11-14**

● ICE MATTE   ● NEUTRAL   ● BLACK   ● TEXT. BLACK   ○ WHITE

<b>0</b> <b>Complet Kit</b> Kit Completo	2CP05600 <b>78</b> 0001	2CP05600 <b>78</b> 0003	2CP05600 <b>78</b> 0004	2CP05600 <b>78</b> 0005	2CP05600 <b>78</b> 0006
<b>1</b> <b>Front A-arms</b> Triângulos da frente	2CP03800 <b>78</b> 0001	2CP03800 <b>78</b> 0003	2CP03800 <b>78</b> 0004	2CP03800 <b>78</b> 0005	2CP03800 <b>78</b> 0006
<b>2</b> <b>Rear A-arms</b> Triângulos de trás	2CP03900 <b>78</b> 0001	2CP03900 <b>78</b> 0003	2CP03900 <b>78</b> 0004	2CP03900 <b>78</b> 0005	2CP03900 <b>78</b> 0006
<b>3</b> <b>Central Carter</b> Carter Central	2CP06600 <b>78</b> 0001	2CP06600 <b>78</b> 0003	2CP06600 <b>78</b> 0004	2CP06600 <b>78</b> 0005	2CP06600 <b>78</b> 0006
<b>4</b> <b>Front Carter</b> Carter Frente	2CP06400 <b>78</b> 0001	2CP06400 <b>78</b> 0003	2CP06400 <b>78</b> 0004	2CP06400 <b>78</b> 0005	2CP06400 <b>78</b> 0006
<b>5</b> <b>Rear Carter</b> Carter Traseiro	2CP06500 <b>78</b> 0001	2CP06500 <b>78</b> 0003	2CP06500 <b>78</b> 0004	2CP06500 <b>78</b> 0005	2CP06500 <b>78</b> 0006
<b>6</b> <b>Side Doors</b> Portas Laterais	2CP05000 <b>78</b> 0001	-	2CP05000 <b>78</b> 0004	2CP05000 <b>78</b> 0005	2CP05000 <b>78</b> 0006
<b>7</b> <b>Front Bumper</b> Pára-choques Frontal	2CP06200 <b>78</b> 0001	-	2CP06200 <b>78</b> 0004	2CP06200 <b>78</b> 0005	2CP06200 <b>78</b> 0006
<b>8</b> <b>Rear Bumper</b> Pára-choques trás	2CP06300 <b>78</b> 0001	-	2CP06300 <b>78</b> 0004	2CP06300 <b>78</b> 0005	2CP06300 <b>78</b> 0006
<b>9</b> <b>Bottom side bar</b> Embaladeiras	2CP05700 <b>78</b> 0001	-	2CP05700 <b>78</b> 0004	2CP05700 <b>78</b> 0005	2CP05700 <b>78</b> 0006
<b>10</b> <b>Rear extenders</b> Alargadores de trás	2CP05200 <b>32</b> 0001	-	2CP05200 <b>32</b> 0004	2CP05200 <b>32</b> 0005	2CP05200 <b>32</b> 0006
<b>11</b> <b>Front extenders</b> Alargadores da frente	2CP05200 <b>32</b> 0001	-	2CP05200 <b>32</b> 0004	2CP05200 <b>32</b> 0005	2CP05200 <b>32</b> 0006

**DTC  
RZR 900 11-14**

● BLACK   ● BLUE   ● RED   ○ WHITE   ● YELLOW   ● ORANGE

<b>1</b> <b>Front A-arms</b> Triângulos da frente	2CP04500 <b>78</b> 0300	2CP04500 <b>78</b> 0400	2CP04500 <b>78</b> 0500	2CP04500 <b>78</b> 0600	2CP04500 <b>78</b> 0700	2CP04500 <b>78</b> 0900
<b>2</b> <b>Rear A-arms</b> Triângulos de trás	2CP11600 <b>78</b> 0300	2CP11600 <b>78</b> 0400	2CP11600 <b>78</b> 0500	2CP11600 <b>78</b> 0600	2CP11600 <b>78</b> 0700	2CP11600 <b>78</b> 0900
<b>3</b> <b>Central Carter</b> Carter Central	2CP14300 <b>78</b> 0300	2CP14300 <b>78</b> 0400	2CP14300 <b>78</b> 0500	2CP14300 <b>78</b> 0600	2CP14300 <b>78</b> 0700	2CP14300 <b>78</b> 0900
<b>4</b> <b>Front Carter</b> Carter Frente	2CP14400 <b>78</b> 0300	2CP14400 <b>78</b> 0400	2CP14400 <b>78</b> 0500	2CP14400 <b>78</b> 0600	2CP14400 <b>78</b> 0700	2CP14400 <b>78</b> 0900
<b>5</b> <b>Rear Carter</b> Carter Traseiro	2CP14500 <b>78</b> 0300	2CP14500 <b>78</b> 0400	2CP14500 <b>78</b> 0500	2CP14500 <b>78</b> 0600	2CP14500 <b>78</b> 0700	2CP14500 <b>78</b> 0900

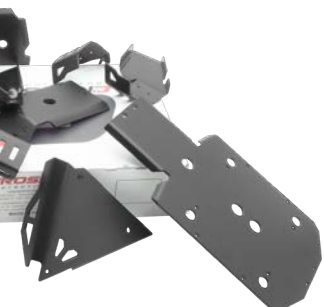

# POLARIS

## RZR 900s

### 2015

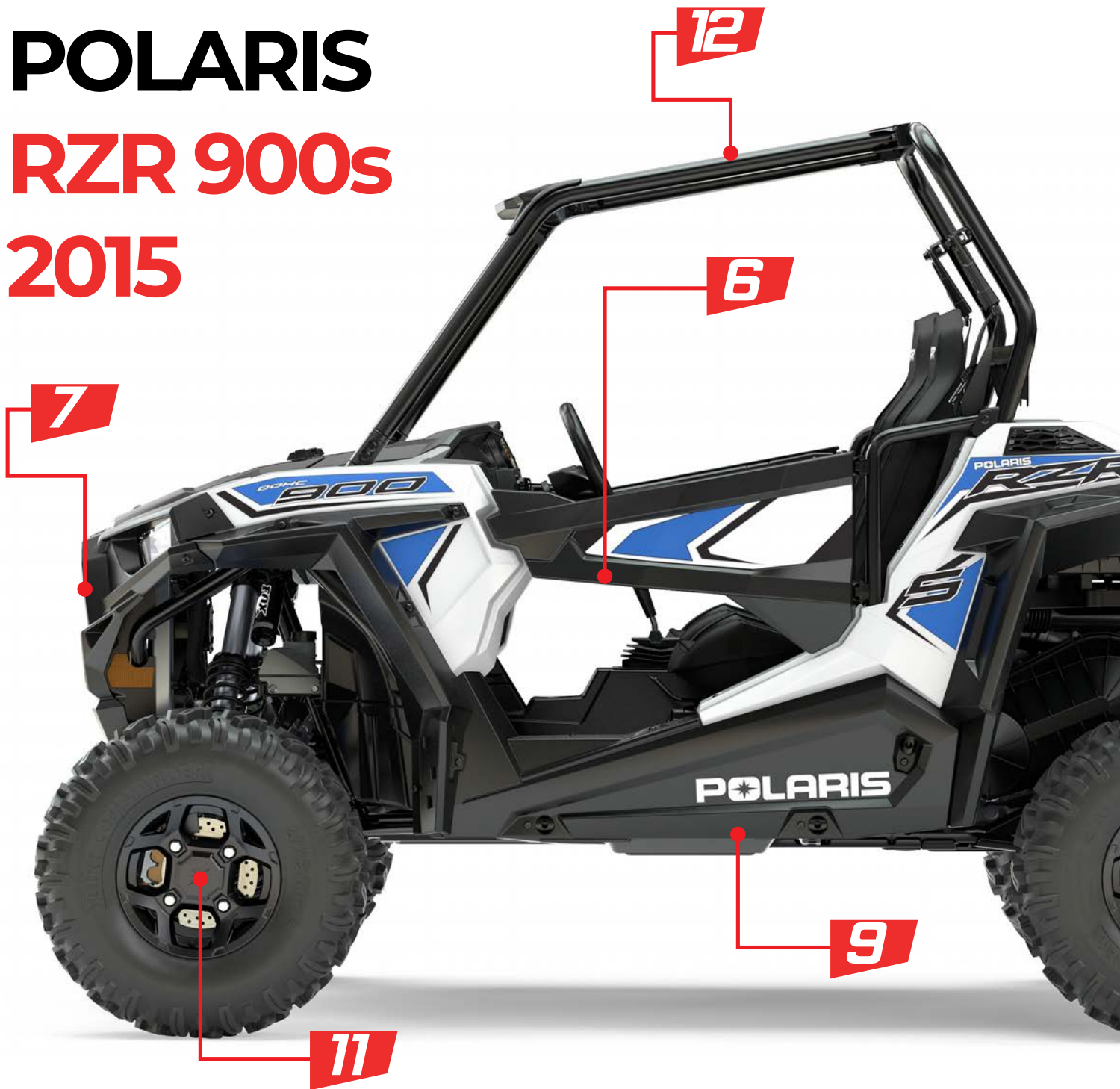

**DORS**  
**RZR 900s 2015**

**6** ● FRAME ICE MATTE

- BLACK  
2CP14800890301
- BLUE  
2CP14800890401
- RED  
2CP14800890501
- WHITE  
2CP14800890601
- YELLOW  
2CP14800890701
- ORANGE  
2CP14800890801



**DORS**  
**RZR 900s 2015**

**6** ● FRAME BLACK

- BLACK  
2CP14800890305
- BLUE  
2CP14800890405
- RED  
2CP14800890505
- WHITE  
2CP14800890605
- YELLOW  
2CP14800890705
- ORANGE  
2CP14800890805

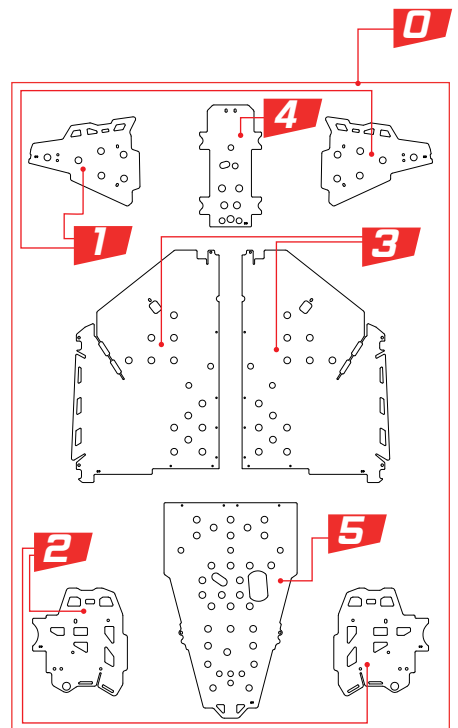

### ALUMINUM RZR 900s 2015

● ICE MATTE ● NEUTRAL ● BLACK ● TEXT. BLACK ○ WHITE

<b>0</b> <b>Complet Kit</b> Kit Completo	2CP05600 <b>89</b> 0001	2CP05600 <b>89</b> 0003	2CP05600 <b>89</b> 0004	2CP05600 <b>89</b> 0005	2CP05600 <b>89</b> 0006
<b>1</b> <b>Front A-arms</b> Triângulos da frente	2CP03800 <b>89</b> 0001	2CP03800 <b>89</b> 0003	2CP03800 <b>89</b> 0004	2CP03800 <b>89</b> 0005	2CP03800 <b>89</b> 0006
<b>2</b> <b>Rear A-arms</b> Triângulos de trás	2CP03900 <b>89</b> 0001	2CP03900 <b>89</b> 0003	2CP03900 <b>89</b> 0004	2CP03900 <b>89</b> 0005	2CP03900 <b>89</b> 0006
<b>3</b> <b>Central Carter</b> Carter Central	2CP06600 <b>89</b> 0001	2CP06600 <b>89</b> 0003	2CP06600 <b>89</b> 0004	2CP06600 <b>89</b> 0005	2CP06600 <b>89</b> 0006
<b>4</b> <b>Front Carter</b> Carter Frente	2CP06400 <b>89</b> 0001	2CP06400 <b>89</b> 0003	2CP06400 <b>89</b> 0004	2CP06400 <b>89</b> 0005	2CP06400 <b>89</b> 0006
<b>5</b> <b>Rear Carter</b> Carter Traseiro	2CP06500 <b>89</b> 0001	2CP06500 <b>89</b> 0003	2CP06500 <b>89</b> 0004	2CP06500 <b>89</b> 0005	2CP06500 <b>89</b> 0006
<b>6</b> <b>Side Doors</b> Portas Laterais	2CP05000 <b>89</b> 0001	-	2CP05000 <b>89</b> 0004	2CP05000 <b>89</b> 0005	2CP05000 <b>89</b> 0006
<b>7</b> <b>Front Bumper</b> Pára-choques Frontal	2CP06200 <b>87</b> 0__	-	2CP06200 <b>87</b> 0__	2CP06200 <b>87</b> 0__	2CP06200 <b>87</b> 0__
<b>8</b> <b>Rear Bumper</b> Pára-choques trás	2CP06300 <b>89</b> 0001	-	2CP06300 <b>89</b> 0004	2CP06300 <b>89</b> 0005	2CP06300 <b>89</b> 0006
<b>9</b> <b>Bottom side bar</b> Embaladeiras	2CP05700 <b>87</b> 0001	-	2CP05700 <b>87</b> 0004	2CP05700 <b>87</b> 0005	2CP05700 <b>87</b> 0006
<b>10</b> <b>Rear extenders</b> Alargadores de trás	2CP05200 <b>46</b> 0001	-	2CP05200 <b>46</b> 0004	2CP05200 <b>46</b> 0005	2CP05200 <b>46</b> 0006
<b>11</b> <b>Front extenders</b> Alargadores da frente	2CP05200 <b>46</b> 0001	-	2CP05200 <b>46</b> 0004	2CP05200 <b>46</b> 0005	2CP05200 <b>46</b> 0006
<b>12</b> <b>Roof</b> Tejadilho	-	2CP17500 <b>87</b> 0003	2CP17500 <b>87</b> 0004	2CP17500 <b>87</b> 0005	2CP17500 <b>87</b> 0006

### DTC RZR 900s 2015

● BLACK ● BLUE ● RED ○ WHITE ● YELLOW ● ORANGE

<b>0</b> <b>Complet Kit</b> Kit Completo	2CP14700 <b>89</b> 0300	2CP14700 <b>89</b> 0400	2CP14700 <b>89</b> 0500	2CP14700 <b>89</b> 0600	2CP14700 <b>89</b> 0700	2CP14700 <b>89</b> 0900
<b>1</b> <b>Front A-arms</b> Triângulos da frente	2CP04500 <b>89</b> 0300	2CP04500 <b>89</b> 0400	2CP04500 <b>89</b> 0500	2CP04500 <b>89</b> 0600	2CP04500 <b>89</b> 0700	2CP04500 <b>89</b> 0900
<b>2</b> <b>Rear A-arms</b> Triângulos de trás	2CP11600 <b>89</b> 0300	2CP11600 <b>89</b> 0400	2CP11600 <b>89</b> 0500	2CP11600 <b>89</b> 0600	2CP11600 <b>89</b> 0700	2CP11600 <b>89</b> 0900
<b>3</b> <b>Central Carter</b> Carter Central	2CP14300 <b>89</b> 0300	2CP14300 <b>89</b> 0400	2CP14300 <b>89</b> 0500	2CP14300 <b>89</b> 0600	2CP14300 <b>89</b> 0700	2CP14300 <b>89</b> 0900
<b>4</b> <b>Front Carter</b> Carter Frente	2CP14400 <b>89</b> 0300	2CP14400 <b>89</b> 0400	2CP14400 <b>89</b> 0500	2CP14400 <b>89</b> 0600	2CP14400 <b>89</b> 0700	2CP14400 <b>89</b> 0900
<b>5</b> <b>Rear Carter</b> Carter Trás	2CP14500 <b>89</b> 0300	2CP14500 <b>89</b> 0400	2CP14500 <b>89</b> 0500	2CP14500 <b>89</b> 0600	2CP14500 <b>89</b> 0700	2CP14500 <b>89</b> 0900
<b>7</b> <b>Roof 6mm</b> Tejadilho 6mm	2CP17300 <b>87</b> 0300	-	-	-	-	-

# POLARIS

## RZR 1000

### 2014-2015



**DORS**  
**RZR 1000 14-15**

**6** FRAME ICE MATTE

● BLACK

● BLUE

● RED

○ WHITE

● YELLOW

● ORANGE

2CP14800870301

2CP14800870401

2CP14800870501

2CP14800870601

2CP14800870701

2CP14800870801



**DORS**  
**RZR 1000 14-15**

**6** ● FRAME BLACK

● BLACK

● BLUE

● RED

○ WHITE

● YELLOW

● ORANGE

2CP14800870305

2CP14800870405

2CP14800870505

2CP14800870605

2CP14800870705

2CP14800870805



7

11

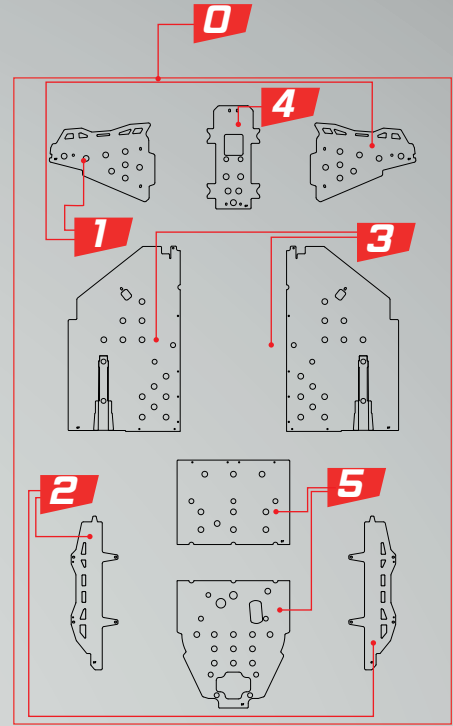

### ALUMINUM RZR 1000 14-15

● ICE MATTE ● NEUTRAL ● BLACK ● TEXT. BLACK ○ WHITE

<b>0</b> Complet Kit Kit Completo	2CP05600870001	2CP05600870003	2CP05600870004	2CP05600870005	2CP05600870006
<b>1</b> Front A-arms Triângulos da frente	2CP03800870001	2CP03800870003	2CP03800870004	2CP03800870005	2CP03800870006
<b>2</b> Rear A-arms Triângulos de trás	2CP03900870001	2CP03900870003	2CP03900870004	2CP03900870005	2CP03900870006
<b>3</b> Central Carter Carter Central	2CP06600870001	2CP06600870003	2CP06600870004	2CP06600870005	2CP06600870006
<b>4</b> Front Carter Carter Frente	2CP06400870001	2CP06400870003	2CP06400870004	2CP06400870005	2CP06400870006
<b>5</b> Rear Carter Carter Traseiro	2CP06500870001	2CP06500870003	2CP06500870004	2CP06500870005	2CP06500870006
<b>6</b> Side Doors Portas Laterais	2CP05000870001	2CP05000870003	2CP05000870004	2CP05000870005	2CP05000870006
<b>7</b> Front Bumper Pára-choques Frontal	2CP06200870___	-	2CP06200870___	2CP06200870___	2CP06200870___
<b>8</b> Rear Bumper Pára-choques trás	2CP06300870001	-	2CP06300870004	2CP06300870005	2CP06300870006
<b>9</b> Bottom side bar Embaladeiras	2CP05700870001	-	2CP05700870004	2CP05700870005	2CP05700870006
<b>10</b> Rear extenders Alargadores de trás	2CP05200440001	-	2CP05200440004	2CP05200440005	2CP05200440006
<b>11</b> Front extenders Alargadores da frente	2CP05200440001	-	2CP05200440004	2CP05200440005	2CP05200440006
<b>12</b> Roof Tejadilho	-	2CP17500870003	2CP17500870004	2CP17500870005	2CP17500870006

### DTC RZR 1000 14-15

● BLACK ● BLUE ● RED ○ WHITE ● YELLOW ● ORANGE

<b>0</b> Complet Kit Kit Completo	2CP14700870300	2CP14700870400	2CP14700870500	2CP14700870600	2CP14700870700	2CP14700870900
<b>1</b> Front A-arms Triângulos da frente	2CP04500870300	2CP04500870400	2CP04500870500	2CP04500870600	2CP04500870700	2CP04500870900
<b>2</b> Rear A-arms Triângulos de trás	2CP11600870300	2CP11600870400	2CP11600870500	2CP11600870600	2CP11600870700	2CP11600870900
<b>3</b> Central Carter Carter Central	2CP14300870300	2CP14300870400	2CP14300870500	2CP14300870600	2CP14300870700	2CP14300870900
<b>4</b> Front Carter Carter Frente	2CP14400870300	2CP14400870400	2CP14400870500	2CP14400870600	2CP14400870700	2CP14400870900
<b>5</b> Rear Carter Carter Trás	2CP14500870300	2CP14500870400	2CP14500870500	2CP14500870600	2CP14500870700	2CP14500870900
<b>T</b> Roof 6mm Tejadilho 6mm	2CP17300870300	-	-	-	-	-



**Europe**

Áustria  
Belgium  
Cyprus  
Czech Republic  
Denmark  
Finland  
France  
Germany  
Greece  
Holland  
Hungary  
Italy  
Latvia  
Lithuania  
Norway  
Poland  
Portugal  
Romania  
Slovakia  
Slovenia  
Spain  
Sweden  
Switzerland  
United Kingdom

**Asia**

Dubai  
Iran  
Israel  
Japan  
Kwait  
Malaysia  
Philippines  
Russia  
Singapore  
Thailand  
Turkey

**AMERICA**

Argentina  
Canada  
Chile  
USA  
Mexico

**OCEANIA**

Australia  
New Zealand

**AFRICA**

South Africa  
Morocco

# CROSSPRO AROUND THE WORLD





A exigência do consumidor, a facilidade com que o mesmo tem acesso à informação obriga a uma constante procura por produtos inovadores assim como pela excelência por parte da CROSSPRO.

Antevendo todas as exigências a que o mercado obriga, assim como os desafios vislumbrados, a CROSSPRO ao longo da sua existência aumentou a sua gama de produtos, levando a uma presença em mais de 40 países. A internacionalização exponenciou as exportações, representando estas cerca de 95% da produção atual da CROSSPRO.

Made by CROSSPRO

The consumer demand, the ease with which it has access to information force a constant search for innovative products as well as excellence by CROSSPRO.

Anticipating all the demands of the market, as well as the challenges envisioned, CROSSPRO has increased its product range throughout its existence, leading to a presence in more than 40 countries. Internationalization expounded exports, accounting for about 95% of CROSSPRO's current production.

Made by CROSSPRO



Indicative weights  
Pesos indicativos

**We have 12  
different colors  
for your guards!**

# electrostatic paint process

*A pintura é realizada através da lacagem, que consiste num processo de pintura eletrostático executado com tintas em pó.*

*Este processo bem como o tratamento a que as peças são sujeitas, reforça a protecção anticorrosiva e maximiza a adesão e duração da tinta.*

*No nosso processo de lacagem dispomos de 12 cores diferentes para as suas protecções. Um processo simples, eficaz e resistente*

*Painting is done through lacquering, which is an electrostatic painting process performed with powder paints.*

*In the lacquering process, the guards can acquire different colors, we have 12 different colors for your guards.*

*This process as well as the treatment to which the parts are subjected, reinforces the corrosion protection and maximizes the adhesion and duration of the paint and initial color.*

*A simple, effective and resistant process*



Ice Polish

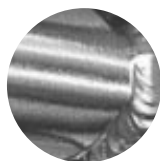

Polish



Natural



Black  
ral: 9005



Textured Black  
ral: 9005 text

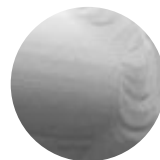

White  
ral: 9110



Red  
ral: 3020



Green  
ral: 6018

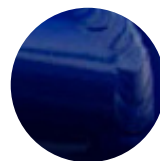

Blue  
ral: 5002



Yellow  
ral: 1021



Orange  
ral: 2004

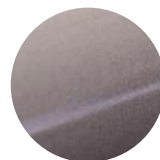

Ice Polish Protected  
varnish color



*“Painting is done through lacquering, which is an electrostatic painting process performed with powder paints.”*

**CROSSPRO**  
PROTECTION PARTS

Zona Industrial do Paraimo, Lote 45  
3780-524 - Sangalhos | Anadia | Portugal

Gps: 40°28'31.0"N 8°28'39.5"W

Phone: +351 234 629 044  
www.crosspro.pt  
E-mail: geral@crosspro.pt



2CPCATOR22



Management  
System  
ISO 9001:2015



www.tuv.com  
ID 9105077726